

Phonecard Collector

Issue 30 February 1995 A\$4.50*RRP

**Marilyn Monroe
is back...
on phonecards
and stamps!**

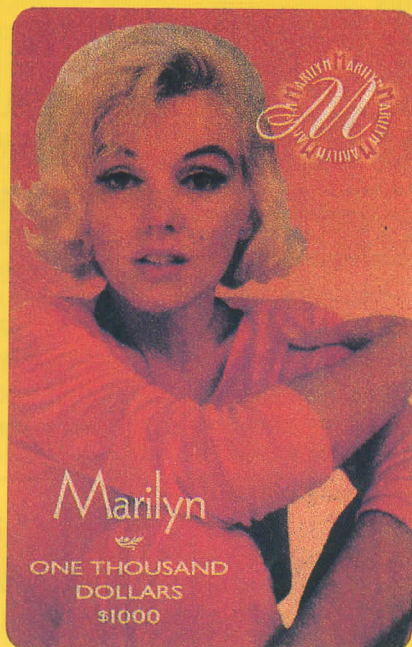

ONLY 3,500 FULL OFFICIAL SETS AVAILABLE



NSW National Parks & Wildlife Service unique fifteen Phonocard Collection



Now the most spectacular strictly Limited Edition collection ever released. These fifteen phonecards are works of art created for the NSW National Parks and Wildlife Service collectable series by internationally acclaimed Australian artist Gregory Bridges. They represent the highest value for money set ever released and are hand matched to ensure each masterpiece in this superb collection has the same serial number. **Hurry, order now before stocks are sold out!**



Limited allocations available to the following Authorised Stockists

- | | | |
|--|--|--|
| <p>NSW
Sydney Stamp Centre
Colonial Mutual Building
Lower Ground Floor
14 Martin Place
Sydney NSW 2000
Telephone 02 231 4583</p> <p>Status Retail
Shop 533 Royal Arcade
255 Pitt Street
Sydney NSW 2000
Telephone 02 267 6116</p> <p>Queen Victoria Coins
Shop 12 QVB Walk
Queen Victoria Building
Sydney NSW 2000
Telephone 02 283 2500</p> <p>Macquarie Coins and
Collectables Gallery
Shop 4, 83 York Street
Sydney NSW 2000
Telephone 02 262 6588</p> | <p>VICTORIA
Knox-Sherbrooke
Phonocards
PO Box 601
Emerald Victoria 3782
Telephone 059 68 5576</p> <p>Max Stern & Co
Port Phillip Arcade
234 Flinders Street
Melbourne Victoria 3000
Telephone 03 654 6751</p> <p>International Numismatics
PO Box 477
Kew Victoria 3101
Telephone 03 882 5910</p> | <p>QUEENSLAND
Tony Boyd
200 Latrobe Terrace
Paddington Brisbane
Queensland 4064
Telephone 07 369 0488</p> <p>WESTERN AUSTRALIA
The Great Aussie
Phonocard Company
PO Box 373
Claremont WA 6010
Telephone 09 386 5113</p> <p>SOUTH AUSTRALIA
Rundle Coins
214A Rundle Street
Adelaide SA 5000
Telephone 08 232 0660</p> <p>TASMANIA
Abacus Stamps & Coins
Shop 10
Mathers Lane
Hobart Tasmania 7000
Telephone 002 34 3494</p> |
|--|--|--|

FREE!
WORTH \$35! 1 YEAR
MEMBERSHIP TO
FOUNDATION FOR
NATIONAL PARKS
& WILDLIFE

If coupon has been removed write to or call: WorldWide Collectables Pty Ltd, ACN 066 438 720 Level 12, 456 Kent St, Sydney NSW 2000. Phone (02) 283 1142 Fax (02) 283 1800

RESERVATION CERTIFICATE



Phone, mail, or fax to: WorldWide Collectables Pty Ltd, ACN 066 438 720. Level 12, 456 Kent Street, Sydney NSW 2000 Phone: (02) 283 1142 Fax: (02) 283 1800

Yes. Please send me my NSW NPWS 15 card Phonocard Collection(s) complete with collector's album as indicated below and enrol me as a member of the Foundation For National Parks & Wildlife absolutely FREE.

- LOW NUMBER EDITION (subject to availability) Issue price \$200 plus \$5.50 packing & certified mail (add extra \$3 for insured mail)
- STANDARD EDITION Issue price \$120 plus \$5.50 packing & certified mail (add extra \$3 for insured mail)

Mr Mrs Ms _____
Address _____

Postcode _____

Cheque/money order enclosed for \$ _____
 Charge my Bankcard Visa Card MasterCard
 American Express Diners Club account with \$ _____

Account No _____

Expiry Date ___/___/___ Signature _____

PLEASE NOTE: SPECIAL SERIAL NUMBERS AVAILABLE ON PHONE REQUEST
Subject to availability for an additional fee.

WorldWide Collectables Pty Ltd reserves the right unto itself at all times to vary the terms of this offer including but not limited to the issue price of the phonecards.

Phonecard Collector

Issue 30 - February 1995

From the publisher

Phonecard values

OUR single most popular editorial feature in *Phonecard Collector* each month, based on reader feedback and letters to the editor, is the Market Report.

This feature values mint (unused) and used (both single-hole and multi-hole) Australian phonecards and is based on an average of leading phonecard dealers' retail prices.

Several readers and callers have commented on the relationship between prices appearing in our Market Report and retail prices charged by dealers for the items listed. Some are higher and some are lower. This should not come as any surprise to the reader, given that it is assembled from a range of dealer pricelists.

Others, especially our younger readers, have suggested that there can be a great variation between the prices quoted in our Market Report and those offered by dealers.

To understand this situation, collectors should consider that the dealer has to make a profit on every transaction. Usually, the margin between a dealer's selling and buying prices is much narrower for the higher priced items (such as South Australia packs).

However, even this "rule of thumb" may not apply when the item is not in heavy demand. If an item is not heavily traded, its retail price may not vary much. Without heavy demand, even though a relatively high price may have become fixed, an item may command only a fraction of retail when offered to a dealer.

Cheaper used phonecards, though popular, are available in very large quantities and, between dealers, may be traded in bundles of hundreds or even thousands. Even though a dealer may sell such a card for between one and two dollars, this represents more of a handling charge than an actual relationship to intrinsic value.

If the dealer has hundreds of a particular card in storage, he will be unwilling to add more to his stock unless it is readily saleable. However, rather than declining to buy further stocks, he may offer a rock-bottom price, thinking that, at such a low level, he will not be buying a "lemon" which will sit in stock and gather dust for years.

Consider for a moment, the plight of the phonecard dealer, who has paid a price, albeit a low one in some cases, for every phonecard in his vast stock. Many such cards will sit on his shelves for years. This ties up money and space. Heavy purchasing in the past may thus limit the dealer's cash flow and ability to purchase what is offered to him by collectors.

So, next time you are ready to condemn the business practices of a phonecard dealer, give a thought to the ramifications of trading in cards.

Brian Moore, Publisher

Contents

Technical Briefing:	Lunar New Year phonecards	18
Smart cards: an introduction	Market Report #7	20
Cover story:	Fundamentals:	
Marilyn Monroe on cards	To begin with	26
News	Phonecard Collector Classified	22
Mini-Display Ads	Currency Collector	29
Asia Watch:	Directory of Advertisers	32
	Directory of Clubs	32

Next month ...

Unfortunately, due to pressure of space, several regular features had to be held over to next month's issue, including *Sydney View* by "Opera House" and *The Speculator*.

Phonecard Collector

(ISSN) 1321-7615 is published monthly at Suite 1403 (14th Floor), 255 Pitt Street, Sydney, NSW 2000, AUSTRALIA. (Visitors by appointment only.)

Members:
ASDA (Melbourne), PTS (London)

Phonecard Collector

GPO Box 3780, Sydney, NSW 2001, Australia

Publisher & Editor-in-Chief

Brian Moore

Publisher's Assistant

Gordon Thomas

Contributing Editor

Torsten Weller

SUBSCRIPTIONS (12 issues)

Australia	A\$43.95
New Zealand, South Pacific	NZ\$69.95
Singapore and other ASEAN countries	Sing\$74.95
China, Hongkong, Taiwan, Japan, South Korea	HK\$450.00
Canada, United States	US\$69.95
United Kingdom, Ireland	stg£49.95
Europe, rest of World	US\$75.00

EDITORIAL & ADVERTISING ENQUIRIES:

☎ (02) 264 7060 Fax (02) 264 7138

ACCOUNT & SUBSCRIPTION ENQUIRIES:

☎ (02) 267 4525 Fax (02) 267 6124

SALES AGENTS

Hong Kong	- NC Yang Stamps & Coins
Indonesia	- Suwito Harsono/TMA
Philippines	- Ponkard World, Manila
Singapore	- Stanley Gibbons (Singapore) Pte Ltd
Sweden	- Boke Stamp Consultants, Göteborg
Taiwan	- Stamp Garden
Thailand	- Siam Stamp Trading Co Ltd

SINGLE COPY PRICE

Australia (*recommended retail)	A\$4.50
Hongkong	HK\$45.00
Indonesia	Rp8000
Japan	¥850
Malaysia	MYR \$10.00
New Zealand (incl GST)	NZ\$5.50
Singapore	Sing\$6.50
Taiwan	NT\$120
Thailand	Bt120
United Arab Emirates	Dhs5
United Kingdom	£4.50
United States	US\$8.50

SINGLE COPY SALES: (Australia)

Sole distributor to newsagents in Australia - Gordon & Gotch, Dealer resale enquiries to Gordon Thomas ☎ (02) 264 7060.

COPYRIGHT 1995

The contents of this magazine are copyright and cannot be reproduced in any way, shape or form without the written consent of the Publisher.

Smart cards: an introduction

By **Phonecard Collector** technical consultant, **Graham Rooke**

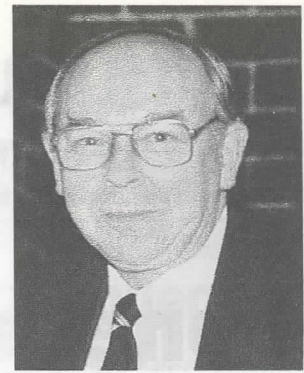

Graham Rooke, technical consultant, Phonecard Collector magazine

CHIP cards or "Smart Cards" as they are often called, provide a relatively new method of carrying monetary credit on a plastic card.

This credit may be used to purchase a range of services, or, in the case of phonecards, a particular service: that of using a prepaid credit to pay for phone calls made from a payphone.

A chip card contains an imbedded electronic circuit - "the chip". The functional complexity of this imbedded circuit determines the area of application of a chip card and the card cost.

The most complex chip provides a full computing function which is designed for financial transaction and other high security applications.

Chip cards suitable for phonecard applications lie at the lower end of the complexity scale. They are cards which have a pre-set monetary credit when purchased - a credit which is progressively reduced as the card is used to pay for calls through payphones. They are often referred-to as "token" cards.

This article explains chip technology as applied to phonecards and how the chip cards are used in a payphone environment. Card costs and payphone operator implementation philosophies are also addressed.

Phonecards with embedded chips

CHIPS imbedded in phonecards are "memory only" chips. Figure 1 shows the internal

layout of a typical phonecard memory-only chip.

Two areas of memory

THERE are two areas of memory. The first memory area is programmed during card manufacture with data that may not be altered in any way.

This data includes the card number, card issuing authority ID and any other permanent data required for the application, such as face value of the card.

The second memory area contains a string of "units" which, during card manufacture, are all set to "available". These units (or "tokens") are progressively programmed through the chip reader as "not available" during or at the end of a call - thus establishing the remaining value of the card (the electronic equivalent of punching holes in a card).

Memory-only card chips are not re-programmable and when all "units" are used, the card must be replaced.

It is interesting to note that the remaining card value is stored only in the internal chip memory and may be read only when the card is inserted into a payphone.

Because there is no visible usage indication (by hole or mark) external on the card, new cards are often sold in sealed plastic bags.

Chip cards are virtually tamper proof. This is a real security "plus" for payphone operators who, worldwide, have been battling with increasing incidence of card fraud.

How are chip cards used?

CHIP cards may only be used in payphones equipped with a chip card reader. The reader comprises a simple set of contact "fingers" which make contact with the chip contacts when the card is inserted.

When a card is inserted, the payphone electronics will read both memory locations and display the remaining card value.

As a call progresses or at the conclusion of a call, the available "units" in memory location #2 are reduced by the amount equal to the cost of the call. At the conclusion of a call it is usual to display the remaining value.

These readers are at once an advantage and a disadvantage to large payphone operators. The big advantage of chip card readers is their simplicity.

There are effectively no moving parts and compared with the most simple magnetic stripe reader, maintenance costs are dramatically reduced.

One big disadvantage to large payphone operators is the cost of conversion away from any other existing technology to re-equip thousands (or tens of thousands) of payphones to chip card operation.

Do chip phonecards look the same?

NO. There are two positions where the chip may be placed on a phonecard. Refer to figure 2 (see page 4).

The international standard position is almost in the centre of the card towards the left-hand edge.

The alternate position, used in the French telecommunications network, is towards the upper left hand corner. This layout usually is identified as a "Telecarte" phonecard.

The chip functionality is the same for both card layouts. It is also interesting to note that some Telecom

Continued page 4

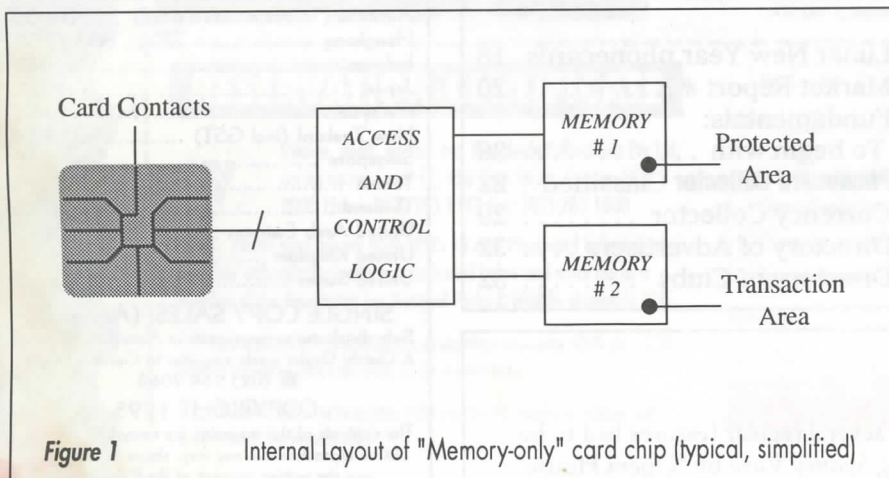

WHAT'S NEW AT PAY•TEL

First PayTel phonecard release for 1995 - available mid February direct from PayTel or your local Dealer.

THE TASMANIAN TIGER

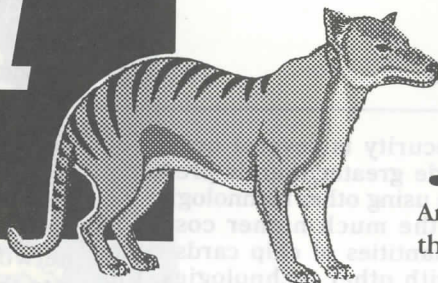

PayTel's "Tiger Pack" features an original hand-painted Tasmanian Tiger phonecard and beautiful forest scene, both by acknowledged "Tiger" artist Anita Khafer.

An authoritative "Tiger Text" is included in the numbered Collectors' pack.

\$10 card / \$15 pack.

VICTORIA'S NARROW GAUGE LINES

PAY•TEL
Railways of Australia
SERIES

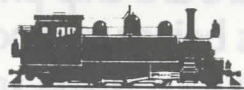

Colac-Crowes; Wangaratta-Whitfield;
Moe-Walballa; Ferntree Gully-Gembrook.

A set of beautiful cards featuring the steam locomotives used on these lines. Cards are available separately, or mounted in an attractive numbered Collectors' Pack - which also includes historical information, photos and maps.

\$19 three card set / \$24 pack.

DO YOU RECEIVE
The Pay•Tel

COLLECTOR

A newsy, informative regular newsletter of interest to all phonecard collectors - gives pictures and stories about all PayTel releases, User Group news, phonecard Editorial - and more!

It's published by-monthly (next issue, February 1995) - and it's free!

If you are not on the "Collector" mailing list - complete the coupon and mail or fax it to PayTel.



PayTel Australia Pty. Ltd.
P.O. Box 456,
Blackburn, Victoria, 3130.
Phone: 877 0222
Fax: 877 9499
Australian Area Code: (03)
International
dialling prefix: +61 3

Please place my name on
The PayTel Collector mailing list.

Name/Business Name _____
Street/P.O. Box _____
Suburb/Town _____
State _____ Post Code _____
Country (other than Australia) _____

authorities (eg, South Africa) print the card image on the smooth (non-chip) side, whilst most other issuing authorities print the card image on the chip side - often making a feature of the chip.

Chip contacts on the face of the card may be gold, silver or nickel plated to provide a continuing good electrical connection with the "fingers" in the chip reader. The contact shapes may vary slightly between chip manufacturers.

How much do chip cards cost?

CHIP cards, like all electronic components, reflect a price which is very quantity-dependent. From a price of approximately \$7 per card (printed) for a quantity of 20,000 cards, the price drops dramatically to under \$1 for a quantity of over 500,000 cards.

Every (new) phonecard sold in Australia is subject to an Australian Government levy of 21% sales tax.

Major Telecom companies throughout the world have the requirements and resources to purchase chip cards in large enough quantities (the order of millions) to make the costs compatible with existing technologies - keeping in mind that one major advantage of chip technology is that remaining

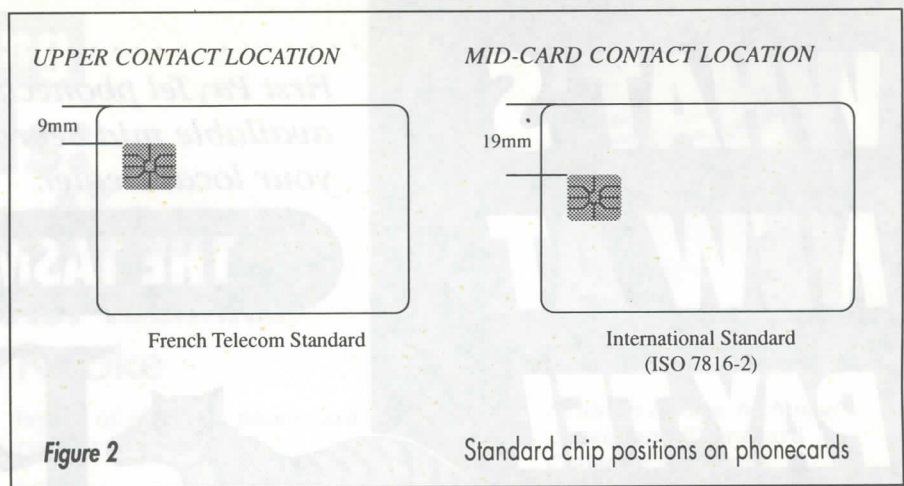

value security is several orders of magnitude greater than is presently available using other technologies.

With the much higher costs for small quantities of chip cards compared with other technologies, the introduction of chip phonecards by small payphone operators could not be justified at the present time on phone usage margins alone.

Where are chip phonecards being used now?

CHIP phonecards are being used extensively throughout Europe. Chip card technology

was introduced as a commercial reality in France. Phonecards utilising this new technology are now an integral part of the French telephone network and are being integrated into the payphone networks of other European countries.

These cards are now in use or on trial in a number of other countries including Isle of Man, South Africa, Ireland, the USA and New Zealand.

The chip phonecard is here to stay, but because of the entrenched technologies in a number of countries (including Australia), changes towards chip phonecards are inevitable but will proceed slowly.

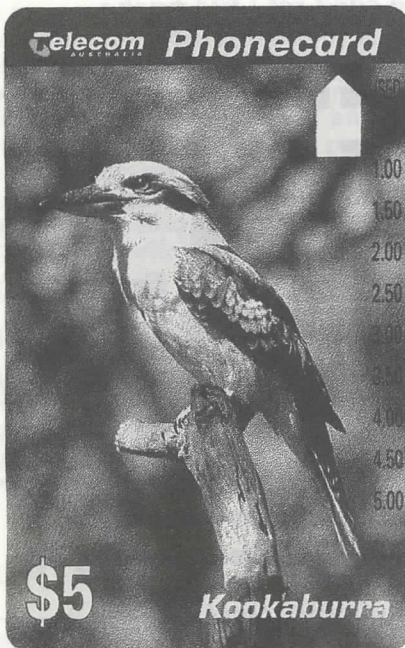

KOOKABURRA

Limited edition Custom Phonocard

Due for release EARLY MARCH

Only 10,000 printed of this unique Australian bird.

Available as 7000 Limited Edition Packs and 3000 Single Phonecards.

This vibrant, true-to-life colour portrait of the LAUGHING KOOKABURRA is presented in only 7000 Collector Packs of top quality, full colour gloss coated A4 folders and only 3000 single collector phonecards packaged to protect the mint condition of your Collector Edition Phonocard.

ORDER NOW!

To add this beautiful phonecard to your collection, order from:

SOUTH COAST PHONECARDS

PO Box 454, Dapto, NSW 2530, Australia.

☎/Fax (042) 62 2688.

Phonocard Pack \$19.50 Single Phonocard \$12.00 1 Pack + 1 Single Card \$29.50

Order to: South Coast Phonecards, PO Box 454, Dapto, NSW 2530, Australia. ☎/Fax (042) 62 2688.

Please supply me with the following:

	Quantity		
Limited Edition Packs	\$19.50	\$.....
Single Phonecards	\$12.00	\$.....
1 Limited Edition Pack &			
1 single Phonocard	\$29.50	\$.....
.....	Plus *Postage \$	3.50
.....	Total \$

*Postage within Australia. All items sent Certified Mail.

Date:...../...../..... Payment Enclosed: Cheque \$..... Postal Order \$.....

Please debit my Credit Card \$..... Bankcard MasterCard Visa

Card No:

Expiry Date: Name on Card:

Signature: Send to:

☎..... Address:.....

The Simpsons and the Flintstones

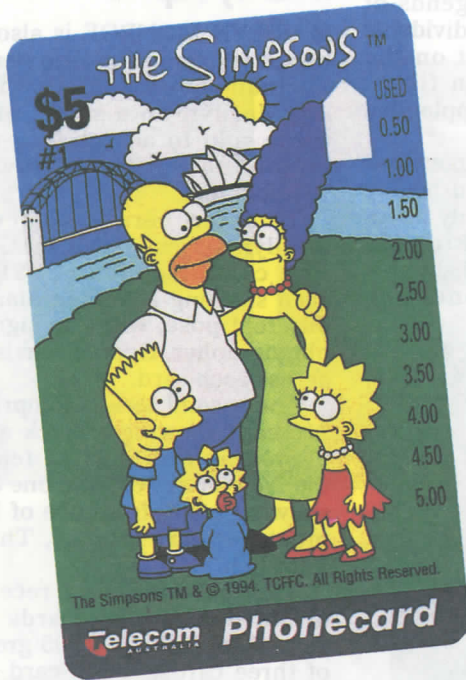

Get your hands on the Official Licensed Flintstones™ and Simpsons™ Phonecards at Issue Price.

Only 5000 Collectors Packs and 3500 Loose Cards will be issued, a small quantity considering the international appeal of both of these animation legends.

All issues are available at Official issue price of \$24.00 per Collector Pack and \$19.00 per Loose Card. And, all collectors ordering from this advertisement will receive the opportunity to place a standing order for future issues with the same serial numbers!

Ensure you don't miss out. Order your Flintstones and Simpsons Phonecards Today today.

**Collector Packs
\$24.00 each
Loose \$5 Cards
\$19.00 each**



INTERNATIONAL NUMISMATICS

GPO Box 4413, Sydney, NSW 2001 Australia
Telephone: (02) 262 4366 Facsimile: (02) 262 6665



QUEEN VICTORIA COINS

Shop 12 QVB Walk, Queen Victoria Building
Sydney NSW 2000
Phone: (02) 283 2500 Fax: (02) 283 2007



Shop 4, 83 York St
Sydney NSW 2000
Phone: (02) 262 6588
Fax: (02) 262 6665

To place Credit Card Phone orders phone

008 81 6677

Also coming soon! Official Simpsons Collector coins!

Name.....

Address.....

.....State.....P/code.....

Phone number during business hours.....

Fax number if available.....

.....The Flintstones \$5 Collector's Pack @ \$24.00 \$.....

.....The Simpsons \$5 Collector's Pack @ \$24.00 \$.....

.....The Flintstones \$5 Loose Card @ \$19.00 \$.....

.....The Simpsons \$5 Loose Card @ \$19.00 \$.....

Postage and Insurance \$ 4.50

Cheque / Money Order enclosed \$.....

Or debit my Bankcard / Mastercard / Visa card

Number

Expiry / Signed.....

Cover story: Marilyn Monroe

Marilyn Monroe phonecards and stamps excite fans

IT was "lights, camera, action" today at New York's Planet Hollywood on January 5 when actress, Marilyn Monroe, was showcased during the premier viewing of a new postage stamp to be issued in her honour by the United States Postal Service.

Postmaster General, Marvin Runyon, unveiled the US stamp design featured on this month's cover, which will add 400 million images of Marilyn Monroe to the already formidable celluloid record that immortalises one of Hollywood's most glamorous stars.

"Today, more than 30 years after her death, Marilyn Monroe's humour still makes us laugh, and her smile still stirs our hearts," said Runyon. "There is only one Marilyn."

Prior to her death on August 5, 1962, Marilyn Monroe completed a legacy of 29 films.

Among them were big box-office successes like *The Seven Year Itch*, *How to Marry a Millionaire*, *Some Like it Hot*, *The Misfits*, and *Gentlemen Prefer Blondes*.

She epitomised Hollywood glamour in its golden age, when kluge lights against the Los Angeles sky signaled the premiere of the next box office smash and the accompanying parties were shared with all of America via movie magazines and gossip columns.

Also Runyon announced that the Marilyn Monroe commemorative stamp is the first in a new series called Legends of Hollywood. Similar

to the very popular Legends of American Music series, Legends of Hollywood will showcase individuals who made a major impact on the development of American films, which are recognised and applauded worldwide.

Of the 40,000 or more suggestions for stamp subjects received by the Postal Service each year, only about 25-30 are selected, making an appearance on a US postage stamp a unique privilege and honour in American life.

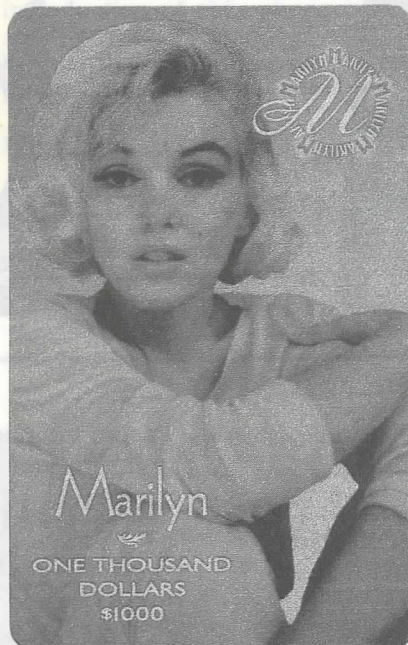

Gem's US\$1000 Marilyn Monroe phonecard.

Marilyn phonecards

MARILYN MONROE is also making her mark on telephone cards. Gem International in California is featuring Marilyn on a series of phonecards sold to access long-distance telephone services provided by Teltrust, Inc.

To date, there have been three Marilyn series issued by Gem. The first comprises four US\$10 cards, each showing a smiling Marilyn in a different pose, with the signature of photographer, George Barris, printed across each card.

The second series, comprising one \$10 card showing a black and white photograph of Marilyn featured in the *New York Post* and one \$20 card, showing a still from one of Marilyn's most popular movies, *The Seven Year Itch*.

The third and most recent series of Marilyn Monroe cards to come from Gem is the 1994/95 greeting set of three cards. A \$10 card wishes a "Merry Christmas"; a \$15 card offers "Seasons Greetings"; and a \$20 card, showing Marilyn with a champagne glass, wishes a "Happy New Year!". This series shows what are believed to be some of the rarest photographs ever taken of Marilyn Monroe. These pictures, taken by George Barris, came to light only recently and were given prominence in the October 1 and 2 1994 edition of the *New York Post*.

World's first \$1000 phonecard

A 10th Marilyn Monroe card issued by Gem has a denomination of US\$1000 - and is claimed to be the highest face value phonecard ever issued. Only 100 were made available for worldwide release.

Sydney dealer, Status Retail, has been appointed Master Distributor for the Gem International Marilyn Monroe phonecard series and invites enquiries from both collectors and dealers. Agent for the United States Postal Service is Max Stern & Co, which welcomes retail and wholesale enquiries.

i Status Retail, PO Box A2176, Sydney South, NSW 2000, Australia. ☎ (02) 267 6116; Fax (02) 267 6124. Max Stern & Co, GPO Box 997H, Melbourne, Vic 3001, Australia. ☎ (03) 654 6751; Fax (03) 650 7192.

AUSTRALIAN INTERNATIONAL PHONECARD FAIR '95

Australia's Major Phonecard Fair

Saturday and Sunday
25th and 26th March 1995
10.00 am to 5.00 pm

HOLIDAY INN MENZIES

Wynyard and Margaret Rooms
14 Carrington Street, Sydney

Australia's and New Zealand's Leading Phonecard Dealers Attending
Plus Telecom Australia, Pay-Tel, Coca-Cola Phonecards

Reserve These Dates - Bring the Family
For Information Phone (02) 913 3036

The Marilyn Monroe stamp will be issued on June 1, 1995, in Hollywood, California. It will go on sale nationwide the same day at 40,000 post offices across the country.

The stamp image was designed by award-winning artist, Michael Dees, who said, "Marilyn possessed a unique combination of sensuality and approachability.

"That's what I tried to capture for the stamp," he said.

Marilyn Monroe on U.S.A. phonecards

Status Retail has been appointed master distributor for an exciting series of phonecards from the United States featuring photographs of the legendary screen star, including some never before published.



Series II:
Black & white shot +
scene from
"Seven Year Itch"
2 cards -
face US\$30
price A\$60

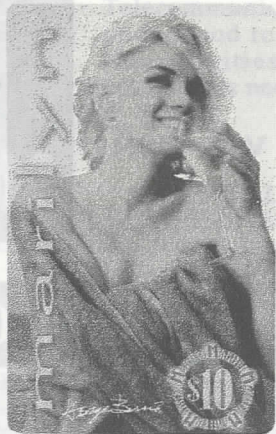

Series I: With George Barris signature
4 cards - face US\$40 price A\$80

Status Retail

PO Box A2176, Sydney South,
NSW 2000, Australia

☎ (02) 267 6116 Fax (02) 267 6124

POSTAGE & PACKING: Certified in Australia
\$2 (loose cards only); \$4 (up to 5 folders);
Overseas Registered Airmail: min A\$12
(loose cards); A\$15 (up to 3 folders);
Ordinary Airmail (your risk) A\$2 (loose
cards); A\$4 (up to 3 folders).

TRADE ENQUIRIES INVITED

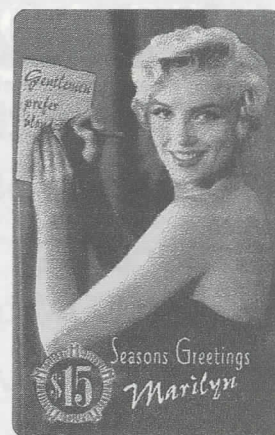
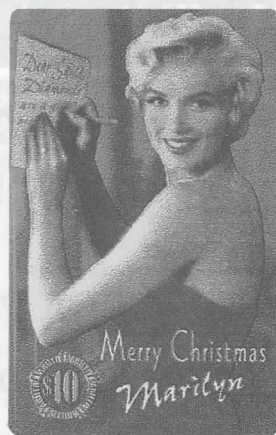

Series III:
Greetings - 3 cards
face US\$45
price A\$75

Visit our Sydney
shop -
Shop 533, Royal
Arcade (underneath
Sydney Hilton),
255 Pitt Street





The Christie Collection
Presents

The PHANTOM of the OPERA

Classic Series 1

NEW RELEASE - LIMITED EDITION

- The Only Official Phonecard For The PHANTOM of the OPERA Authorised By Andrew Lloyd Webber
- World First To Australia
- High Quality A4 Presentation Packs
- Delivery: Late Feb., Early March
- Only 4,000 Packs

Phone: (059) 673600

Fax: (059) 673463

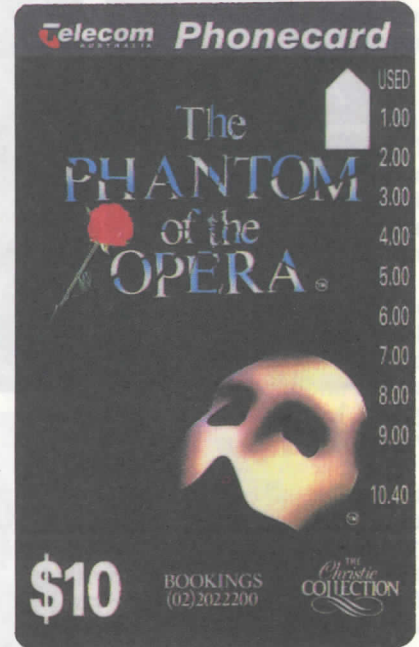

ORDER NOW TO SAVE DISAPPOINTMENT

To: **The Christie Collection**
PO Box 255, Warburton, Victoria 3799

Please Send Me:	Price	Quantity	Total
The PHANTOM of the OPERA Pack	\$37.90	<input type="text"/>	\$ <input type="text"/>
Express Post/Packaging (Inc. Insurance) > 1-2 pcs @	\$8.00		
Additional Packs up to 10, add \$2.00 each			\$ <input type="text"/>

Enclosed is my Cheque/Money Order or Cash

Please Debit my Credit Card Account

Bankcard Mastercard Visa American Express

Amount Due \$

CREDIT CARD No. _____ Exp. date _____

Your Signature _____ PH Bus _____

Name _____ PH Home _____

Address _____

_____ Postcode _____

Newcastle Collectors Expo

Stephen Blyth and Dietmar Lederwasch are organisers of the inaugural Newcastle Collectors' Expo and believe that this event will be the biggest of its kind ever staged in the Southern Hemisphere.

The two have spent months visiting trade fairs all over all Australia and putting together a mailing list of collectors and dealers. The event they have organised has attracted the support of two major trading card companies.

Mr Lederwasch is an avid collector of comics and animation art who has been fortunate enough to make his passion his business.

The organisers are expecting collectors to come from most Australian states, New Zealand and further afield.

Apart from phonecards, dozens of other hobbies will be represented. There will be 100 stalls where enthusiasts can indulge themselves in what ever collect, from animation art to Beatles memorabilia; Disneyana to Star Wars and Star Trek; movie memorabilia, computer games, stamps and model trains to highlight only a few.

Collectors will be able to get free valuations of their collections by experts. Advice will also be available as to preservation and building of collections. There is even a stall where information can be obtained about insurance of collectables.

Two US trading card companies are providing a quantity of giveaways for the showbags available to visitors.

The Expo will take place on Saturday and Sunday, March 4-5, at the Newcastle Basketball Stadium, Broadmeadow.

i Newcastle Exhibition Consultants, 8 Pacific Street, Newcastle, NSW 2300, Australia. ☎ (049) 26 1420; Fax (049) 25 2787.

Cheaper overseas calls for Australians?

AUSTRALIANS are being offered cheaper overseas calls through the competitive United States based networks, some of which offer phonecard type products. Others are accessed simply by quoting a credit card number. Still other networks offer a combination of both, issuing a type of phonecard with an account number and, for security, a PIN (personal identification number) - with customers "topping up" the call value available on their card by debiting a certain amount from their credit card.

An increasing number of Australians

(and overseas visitors) are taking advantage of cheaper calls offered by US-based companies known as "callback" service providers, including Telegroup and Mastercall.

The call back service providers are accessed by calling a 1 800 number.

It is claimed that calls to the USA and Europe may be as much as two-thirds cheaper than calls made via Australia's telephone networks.

Approximately A\$2 billion in calls are made each year from Australia to overseas numbers - suggesting that this market will be open for a lot of competition in the future.

Whilst there are clams of some abuses of the overseas call-back systems (such as debiting a credit card without delivering service), Austel, the Australian telecommunications regulatory authority, says that operators must register with it, but they do not require a licence.

Call-back has been banned in some countries, and the International Telecommunications Union (I.T.U.) is understood to be examining whether the activities of call-back service providers is needful of regulation.

Two-day fair

AUSTRALIAN INTERNATIONAL PHONECARD FAIR '95, to be held in Sydney in March, has been expanded to a two-day fair.

The fair was previously held over a weekend in conjunction with the Australian International Banknote Fair. Although phonecards were featured at the banknote fair and phonecard activity overwhelmed the banknote business, the phonecard fair was officially a one-day event.

Starting with the March fair in Sydney (March 25-26), it will be expanded to a two-day fair, and only phonecards and related phonecard memorabilia and ephemera will be sold at the fair.

The fair will be open to the public from 10am to 5pm on both days at the Wynyard and Margaret Rooms, Holiday Inn Menzies Hotel, 14 Carrington Street, Sydney, New South Wales.

i MEF Books, PO Box 523, Narrabeen, NSW 2101, Australia. ☎ (02) 913 3036.

Custom cards

TELECOM has advised of the forthcoming release of the following advertising cards:

The Melbourne Phonecard Club is releasing 10,000 \$2 cards featuring Melbourne Zoo.

Roam Pacific is releasing a series of four cards featuring sporting heroes and a series of three cards marking the

Middle East Peace talks.

P.A.C.S. is releasing a \$5 card on behalf of the Australian Conservation Foundation and two \$5 cards for the RSPCA.

Australian Phonecard Service has released two \$5 cards commemorating the 20th anniversary of Cyclone Tracey.

P.J. Seiders has released a \$5 card for the Kidney Foundation.

Phone Australia card

TELECOM has introduced a prepaid international calling card know as the Phone Australia Card. It can be used to make calls from overseas to back home to Australia, allowing travelers to avoid surcharges such as operator or hotel costs

Available mainly through retail outlets found in international terminals and travel agents, the card comes in denominations of \$10, \$20 and \$50.

It is activated by use of a PIN number, which will be purchased with the card in a sealed security envelope, allowing customers to easily see that the card is unused. Initially 20,000 of each denomination have been produced.

Telecom/Note promo

TELECOM and Note Printing Australia will commemorate the centenary of Banjo Patterson's *Waltzing Matilda* with a joint product featuring the \$10 polymer note already in circulation and a \$10 phonecard.

The project is the first official joint promotion for Telecom. There will be two different varieties of the folder, which will be unlike any other folder that Telecom has produced - 1000 Premium Portfolios, with the lowest 1000 serial numbers printed on both the bank note and the Phonecard in red, and 4000 Deluxe Portfolios, with the next 4000 serial numbers appearing in blue.

NSW PHONECARD, STAMP, COIN & COLLECTABLES FAIR

Sunday 26th February 1995
10.00 am to 5.00 pm

HOLIDAY INN MENZIES

Wynyard and Margaret Rooms
14 Carrington Street, Sydney

For Information Phone
(02) 913 3036

MINI-DISPLAY ADS

Mini-Display Ads are an economical way of keeping your name and specialities in front of collectors (and dealers) in the **Phonecard Collector**. Mini-Display Ads are sold in modules 41 x 41mm in size. Advertisers may elect to take multiple modules pro-rata. Although Mini-Display Ads may be booked casually by dealers, clubs and societies and individual collectors, there are *big savings* if the same ad is booked (and paid for in advance) to run for 12 consecutive issues. A single insertion of one 41 x 41mm module costs A\$30. Book and prepay for a series of 12 Mini-Display Ads in the **Phonecard Collector** for only A\$240 — a **saving of one-third!** (Copy must not be changed.) All Mini-Display Ads are priced nett — no further discount allowed.



PO Box 9094, Te Aro, Wellington
NEW ZEALAND

New Zealand's largest variety of Phonecards.

• BUY • SELL • EXCHANGE •

Hendro Winatan

☎ +64 4 385 1908

Fax +64 4 385 1908 +64 385 1214

TRADING IN ITALIAN, VATICAN AND SAN MARINO TELECARDS

NEW RELEASE SERVICE. SEND YOUR REQUEST TO:

ANTONIO MASSONE
Via ASINARI DI BERNEZZO 7, 10145 TORINO, ITALY

RUGBY LEAGUE:

Official Australia V Great Britain 1994 Ashes Tour Commemorative Phonecard. Great Britain Rugby League Logo includes the British Lion and Australian Kangaroo!!

Extremely good colour. Limited number available. Send cheque/postal order A\$30 including P & P to:

C.P. MANAGEMENT
P.O. Box 2, London W2 4ZY, England.

To be offered at auction in Sydney by Status Auctions International on March 29 1995

From \$50 to \$50,000...

Whether your consignment of coins, banknotes, medals (or, for that matter, stamps or phonecards) is worth \$50 or \$50,000, Status will help you with confidential and professional advice.



\$2 Commonwealth of Australia star notes (Phillips/Randall) with consecutive numbers

Our team of experts is available to value your consignment and recommend the best means as to its disposal. Write or speak to Barry Jarrett at Status Auctions International for a free, frank and confidential assessment of the worth of your numismatic (or philatelic) property.

Ask for a list of other fine numismatic materials on offer in our February 8 sale - our 158th

Status Auctions International

14th Floor, 255 Pitt Street (Sydney Hilton Building), Sydney, NSW 2000, Australia
Postal: PO Box A2176, Sydney South, NSW 2000, Australia

☎ (02) 267 4525 Fax (02) 267 6124

Phonecard Collector Classified

Basic **Phonecard Collector Classified** advertising rate is 50 cents per word, minimum 20 words (A\$10). **Bold type** is available at 75 cents per word. Book (and pay for) your word ad to run in two consecutive issues of **Phonecard Collector** ... and we'll run it in the third consecutive issue **absolutely FREE!** Book and pay for your ad to run in five issues ... and we'll run it for three months **FREE!** (That's *eight months of ads for the price of five!*) Book and pay in advance for your ad to run in seven issues ... and we'll run it for the rest of the year **absolutely free!** (That means *you get 12 months of ads in Phonecard Collector for the price of seven.*)

American Express, Bankcard, Diners' Club, JCB, MasterCard, Visa welcome.

COLLECTOR PUBLICATION - Credit cards / phonecards - official tips / official trends - 12 issues US\$30 (US funds). **LIN OVERHOLT**, Box 8481, Madeira Beach, FL 33738, USA. 3041

GTE Hawaii and USA cards. Free list. **H. WILLKOMM**, Bruchstr. 69, 45468 Mülheim, Germany. Fax +49 208 47 39 20. 3030

PHONECARDS, Indian Motorcycle Series I, II & III; Hightimes phonecards Series I; Supermodels Series I. Wholesale and retail. **COWLEY'S MOTORCYCLES**, 62 Napoleon Street, Port Lincoln, SA 5606, Australia. ☎ (086) 82 6026; Fax (086) 83 0784. 3032

POSTAL AUCTION from \$1. Mint - used - errors. Buying cards. Genuine private collector. **BEN GIDDINS**, PO Box 367, Lochinvar, NSW 2321. 3030

CHINA 20 used phonecards only US\$28/A\$36 (cash). **XUWEL**, 204-2 Longkang Bridge, Suzhou 215008, China. 3030

APPROVALS: Selling phonecards from over 100 countries. Will arrange a lot to suit your requirements (mint, used, packs). Thematics, eg Trains, Cars, Animals, Scenery, Coke, etc. Large range available. Please write for details to **JUST PHONECARDS P/L**, GPO Box 3677, Darwin, NT 0801, Australia. 3032

FOR SALE: Australian phonecards. Huge private collection collectors' packs, mint cards, less 10%, 20%. Have 10,000 one- and multi-hole cards, early to latest, from 50c. No dealers. ☎ (02) 624 5996. 2931

FRANCE phonecards, great designs, pictorial. 10 different A\$17; 20 different A\$40; 30 different A\$70; 40 different A\$100; 50 different A\$150. Certified Mail post free. **W.C.P.**, PO Box 177, Tumby Bay, SA 5605, Australia. 2931

PAKISTAN 25 different or 35 mixed fine used only for A\$50; registered air post paid; Cash with order; or just send A\$5 for our retail/wholesale price lists with introductory discount offers PLUS 3 sample cards. **EASTLINK PHONECARDS**, 190-B-2, P.E.C.H.S., Karachi 75400, Pakistan. Fax +92 21 454 6002. 2931

FIRST CHINA TELECOM PHONECARD and a lot of Chinese provincial phonecards for sale. Write: **LI LIN**, Private Box 282, 422 Pitt St, Sydney, NSW 2000, Australia. ☎ (02) 968 4895. 2931

ARABIAN GULF PHONECARDS: Send 10-20 or more phone cards of your country to receive same amount: **M A NAEEM**, Postbox 14283, Doha, Qatar. 2830

DIRECT FROM JAPAN: selected mint phonecards including regional issues. Large or small quantities. Sydney fax number enquiries only: Fax (02) 958 7709. 2830

AUSTRALIAN packs, mint, one hole used cards at well below dealers' prices. Ring for our best quote or send want list for immediate reply. **J BESTE**, PO Box 877, Mudgeeraba, Qld 4213, Australia. (075) 30 3157. 2830

SELLING excess material. Collector (Australia, NZ, South Africa) sell/exchange surplus items. Also interested in wildlife cards worldwide:

PHILIP ALEXANDER, PO Box 130, Market St Post Office, Melbourne, Vic 3000, Australia. ☎ (03) 641 4377 B/Hrs; (03) 641 4377 A/Hrs. 2830

WANTED: Australia phonecards. Can send Malaysia / Singapore / Taiwan phonecards. Minimum 20 cards each time. **CAI YI KUN**, 126 Kim Tian Road #04-81, Singapore. 2831

SPORTSCARDS USA SELLING COLLECTABLE PHONECARDS: Largest selection of U.S. and foreign. Specialising in mint "Hard-to-Find" Japanese Disney, sports and entertainment. Used also available. We stock U.S. sports, entertainment, promotional and more. Starter packages available. Wholesale to collectors. Call/Fax **SPORTSCARDS U.S.A.**, ☎ +1 305 748 7299. 2830

EXCHANGE Belgium (used) against World (used). Good quality. **HENRI DE WACKER**, Zevenbergenlaan 11, 2660 Hoboken, Belgium. (+32 3 827 91 57. 2830

BUYING: Australian used phone-cards, no bends or scratches. PAYING 15% face value. Immediate CASH payment. (Larger amounts by money order.) **RICHARD FOSTER**, PO Box 662, Blacktown, NSW 2148, Australia. 2830

BUYING phonecards from Australia and New Zealand, used, no scratches or bends. Send details to: **ALEX STANIMIROVITCH**, PO Box 643, Wangaratta, Vic 3676, Australia. 2830

SELL, EXCHANGE used European phonecards. 100Bfr or A\$4 for one. **PIERARD JEAN-MARC**, Av Ferdauci 16, 1020 Bruxelles, Belgium. 2830

FAIRDINKUM SALE. New concept. Good offers secure Australasian, early Nynex/Hawaii, Mercury, Aviation, more. First issues/classics like Fernleaf, Geneva, Democrats. Sorry, no dealers, only underdogs please. Details: **KEANACORP**, 54 Medan Athinahanpan 2, TTDI, 60000 Kuala Lumpur, Malaysia. 2734

BUYING: Australian mint and fine used phonecards. Offers to: **HM REED**, PO Box 659, Salisbury, SA 5108, Australia. 2738

FINLAND 40 different used phonecards A\$280 or 20 different A\$100 postpaid by registered air letter. Visa, MasterCard or banknotes. **K-J ÖSTERMAN**, Pl 1, Fin-02231 Espoo, Finland. Fax +358 0 803 9038. 2633

BUYING: Top prices paid/packs, mint, used, bulk lots. **SELLING**: Quality Australian packs. Huge stocks. Send want list. Any dealers/ collectors not on our lists are welcome to state interests. Please write or fax **APC PHONECARDS**, PO Box 579, Ashmore City, Qld 4214, Australia, or ☎/Fax (075) 94 0982. 2830

BAHRAIN PHILATELIC CENTER. Buying, selling, exchanging phone-cards, stamps, banknotes. Special personal/dealers' offer. Try Bahrain/ Gulf beautiful phonecards, stamps. PO Box 33555, Bahrain. 2536

CHINA PHONECARDS, stamps, coins for sale. Free pricelist available. **XU HANG**, PO Box 275-12, Beijing 102413, China. 2330

BUYING/EXCHANGING phonecards from all over the world, but especially "difficult" countries. Payment cash cheque any currency. Send details to **HAXBY STAMPS**, PO Box 462, Lutwyche, Qld 4030, Australia. 2536

EXCHANGE PHONECARDS: Send 100 pictorial mix fine used from Australia, Japan, Indonesia, Korea, China: Receive 200 pictorial Italy. **CAFFO CARMELA**, Via Wagner 103, 95024 - Acireale - CT, Italy. 2431

EXCHANGE: Offer - used German/ European phonecards and stamps. Wanted - used & mint Australian and New Zealand phonecards plus used Asia. **ANJA VERENA HOLL**, Lotschnauer Weg 1, 73054 Eisingen, Germany. 2334

FOR SALE: 50 different Japan A\$59; registered postpaid. Free worldwide pricelist. Australian USA cheques acceptable. **EVELYN REECE**, Box 207SC, Cainta, 1900, Philippines. 2234

WANTED: Used Australian phonecards 1-hole 15%; multi-hole 10%. Send details or photocopy to **NOEL SHONE**, PO Box 404, Blackburn, Vic 3130, Australia. 3030

FOR SALE: Latin America phone-cards. Send A\$2 mint face value stamps or equivalent for list. Easy payment, references. **BIANCO**, PO Box 56, 65000 Fray Bentos, Uruguay. 1930

AUSTRALIA AND NEW ZEALAND THEMES on Japanese cards. A\$10 to A\$100. Write for details. **BRUCE PHILLIPS PHONECARDS**, PO Box 24-199, Christchurch, New Zealand. 0031

BUYING/SELLING Australian mint and fine used Phonecards. Free selling list available. **BRIAN NOBLE**, PO Box 427, Ryde, NSW 2112, Australia. 2031

CAN SUPPLY new/unused China phonecards at relatively low prices. Blk 342, #11-29, Choa Chu Kang Loop, Singapore 2368. Fax +65 765 2310. 2132

PHONECARDS used - all different. 17 Japanese \$20; 45 Japanese \$50; 15 World. **JOHN THOMAS**, PO Box 428, Rosebud, Vic 3939, Australia. F3030

WANTED: Prices at which you will sell me NZ or Australian phonecards. Please send your selling lists. **KEN BENDALL**, 5 Bell Street, Hamilton, New Zealand. F3030

PHONECARDS used all different: 10 Belgium \$10; 10 Dutch \$10; 12 British \$10. **JOHN THOMAS**, PO Box 428, Rosebud, Vic 3939, Australia. F3030

AVAILABLE for sale. Australian phonecard from Geelong to Christmas 1994. Mint, used, fair prices. **S. & T.**, Box 7, Avondale Heights, Vic 3039, Australia. F3030

CAMBODIA used. Prefix 185, 252, 253, 258, 289, 290. Exchange for mint Australian. **MR F COAD**, ☎ (08) 258 7608, South Australia. F3030

EXCHANGE/BUY phonecards from collectors in China and Taiwan. **S.TAN**, 22 Erskine Street, North Melbourne, Vic 3051, Australia. F3030

Phonecard Collector Classified ... It really works!

SELLING and EXCHANGING Australian phonecards. Send want lists with stamp. **DANIEL RUCCI**, 589 Morley Drive, Morley, Perth, WA 6062, Australia. ☎ (09) 275 9370. F3030

WANTED: Mint and used world motorsport phonecards, particularly Formula One. Send list or photocopy. **JOHN TETLEY**, 8 Booralgal Place, North Nowra, NSW 2541, Australia. F3030

EXCHANGE Singapore used cards for world used cards. Free list. **NICK McEWAN-HALL**, 66 Queens Road, Connells Point, NSW 2221, Australia. F3030

SELLING: Packs and loose cards from Geelong to recent issues. Private collector will consider trade. ☎ (07) 202 1386. F3030

SELLING: \$1.50 Surf Boat (Geelong) absolute mint. Great price. **AH** (only 054) 28 5114. F3030

JUNIOR COLLECTORS of used phonecards to swap with three junior collectors. **D. LORRAWAY**, 64 Dee Street, North Rockhampton, Qld 4701, Australia. F3030

EXCHANGE used phonecards, FDC and commemorative stamps from Hong Kong for phonecards from all over the world. **CECILIA WONG**, 24B Hoover Heights, Belair Gardens, Shatin, Hong Kong. F3030

WANTED Cashcard Pyramid Building Society (perfect condition): swap for five used Australian phonecards. **TROWBRIDGE**, Private Bag Three, Kembla Grange, NSW 2530, Australia. F3030

WORLDWIDE PHONECARD EXCHANGE (mint/used). Any quantity of any countries. Also buying and selling world cards. Large stock of Malaysia/Singapore. **JACKY NG CHEE LENG**, 44-C Jalan Jaya, 80400 J.B. Johor, Malaysia. F3030

CARDS from Australia, Singapore, Malaysia, Finland, Sweden, NYNEX available. **LKM**, Blk 224, Pasir Ris St 21, #12-140, Singapore 1851. F3030

EXCHANGE One Melbourne pack for the following complete packs: Landscapes '94, Commonwealth games, Tamworth Music Festival and Cardex '94. **C. RICHARDSON**, 47 Portland Road, Elizabeth East, SA 5112, Australia. F3030

10 DIFFERENT countries pictorial phonecards. Post free \$12. **E. BOXALL**, 11 Wardrop Street, Mackay, Qld 4740, Australia. F3030

PHONECARDS - stamps. Every Sunday, Trash & Treasure Market, Palais Car Park, North Terrace, Adelaide, opposite R.A.H. F3030

EXCHANGE - send 5-20 of your country to receive same amount of Australia. **MARK SELBY**, 4 Rakeville Road, Graceville, Qld 4075, Australia. F3030

SINGAPORE 1994 Phonecard Exhibition pack (NZ\$15); Hari Raya 1994 pack (NZ\$38); International Year of Family pack (NZ\$11); cash on delivery (C.O.D.). **DANIEL WEE**, Blk 32 Cassia Crescent #09-50, Singapore 1439. F3030

10 SINGAPORE used phonecards A\$15; 20 different A\$25. Payment in equivalent banknotes. **DANIEL**

LYE, 62 Fidelio Street, Singapore 1545. F3030

EXCHANGE used with Singapore / China / Pacific Islands. **E.C. ANG**, 12 Tingkat Sentosa, 14000 Bkt. Mertajam, Penang, Malaysia. F3030

WORLDWIDE PHONECARDS wanted. Send minimum 20 used phonecards in exchange for 20 Indonesian used cards. Mint cards also available. **ISKAK NURARIF**, Jl. Taman Kedoya Raya F-4, Jakarta 11520, Indonesia. F3030

PAKISTAN fine used and mint available. Send A\$5 for pricelists with three sample cards. **EASTLINK PHONECARDS**, 190-B-2, PECHS, Karachi #75400, Pakistan. Fax +92 21 454 6002. F3030

PACKS FOR SALE: Dinosaur \$170; Commonwealth Games \$90; Landscape '94 \$95; Endangered Species '94. **ALLEN SUSS**, PO Box 376, Moorabbin, Vic 3189, Australia. ☎ (03) 555 2733; Fax (03) 553 3802. F3030

EXCHANGE used Australian phonecards for all world 1:1 basis. **N. MALEK**, unit 29/2A Inga Street, Clayton, Vic 3168, Australia. F3030

SEND MINIMUM 20 different used world phonecards in exchange for 20 different used Malaysian phonecards. All letters answered. **BASIL GOMEZ**, 11 Jalan 4/52C, 46050 Petaling Jaya, Selangor, Malaysia. F3030

ADVERTISERS: If the last two digits in the four-digit code after your ad end in "30" or "31", now is the time to renew or place a new ad. Write, 'phone or fax today!

NEWCASTLE COLLECTORS EXPO - MARCH 4-5, 1995

The largest collection of popular culture gathered together in the Southern Hemisphere.

Newcastle Basketball Stadium Broadmeadow

The Newcastle Collectors Expo will be the place for enthusiasts of the following:

- Trading cards - sports and non-sports • Comics
- Australian and U.S • Phonecards • Animation
- Art • Matchbox collectibles • Japanese Manga

- Cigarette Cards • Disneyana • Beatles
- Autographs • Laser Discs • Computer Games
- Dr Who • Star Trek • Star Wars • Records & CDs • Stamps • Coins • Model Kits • Coca-Cola
- Dolls • Toys • Trains • Books • Watches
- Movie Memorabilia • Role Playing • Militaria, etc, etc

FREE valuations for your own collection by experts. Find out how to insure your collection; how to preserve it, build on it, or even sell it! For more information,

☎(049) 26 1420 / 018 49 9912 / Fax (049) 25 2787

Harbour City Stamps & Phonecards

Your full service phonecard and stamp shop in the heart of Sydney's Chinatown

DISNEY AUSTRALIA packs for sale: A\$40 each. A\$350 for 10 packs.

MOON LANDING 25th ANNIVERSARY (Roam). Good numbers such as 1111, 1222, 1333, 1666, 1777, 1888, 1999 etc available at A\$350 each.

TELECOM AUSTRALIA Collector editions: NSW A\$500; Grand Prix A\$100; 1993 Endang. Species A\$150; 1994 Endangered Species A\$110; Landscapes A\$110; Commonwealth Games A\$90.

CUSTOM PACKS: Ettamogah Pub \$40; MCA \$75; Opera House \$70; Spies Hecker \$60; ASDA \$24;

CHINA PHONECARDS (all are mint, complete sets):

Jiangsi 1993 Mao Zedong (6) A\$55; 1993 Romance of the Western Chamber (4) A\$60; 1993 Lunar New Year stamp cards (12) A\$95; Tianjin 1st set (10) A\$300; Hebei set (3) A\$75; Hunan 1st set (5) A\$195; Jilin 1st set (4) A\$175; Kunming 1st set (10) A\$290; Shanghai 1st East Asian Games set (5) A\$180

DELIVERY: All orders in Australia by Certified (add A\$4). Add A\$14 for secure delivery outside Australia (by air).

Harbour City Stamps & Phonecards

(Alan Liu)

Suite 345, Level 3, Sussex Centre, 401 Sussex Street, Sydney

PO Box K869, Haymarket, Sydney 2000, Australia

☎ (02) 281 1152 Mobile: (0414) 368 238 Fax (02) 959 5159

Status Retail

Australian Phonocard Pricelist

Welcome to the second instalment of our phonocard pricelist. The first part, published in last month's **Phonocard Collector**, lists cards from all around the world, by country and by theme (if you don't have a copy available, we would be glad to send you photocopies of the list).

This month's instalment covers Australia (Telecom, Pay-Tel, Cardphone issues), Telstra International Issues (Cambodia, Christmas Island, Norfolk Island, Rwanda and Vietnam) and New Zealand Advertising issues.

Order using the unique Card Codes

You assist us in processing your order promptly by using the codes for each phonocard printed in the left-hand column. Please also include a short description of the card to avoid any errors.

GEELONG LIFESAVING

RRLS9001	\$1.50 Go Together	Mint	A\$85
RRLS9002	\$1.50 Go Together	1-hole	\$85
RRLS9003	\$1.50 Go Together	Used	\$70
RRLS9004	\$3.00 Float & Wave	Mint	\$15
RRLS9005	\$3.00 Float & Wave	1-hole	\$12
RRLS9006	\$3.00 Float & Wave	Used	\$8
RRLS9007	\$6.00 Reach to Rescue	Mint	\$15
RRLS9008	\$6.00 Reach to Rescue	1-hole	\$10
RRLS9009	\$6.00 Reach to Rescue	Used	\$8
RRLS9010	\$1.50 Surf Boats	Mint	\$40
RRLS9011	\$1.50 Surf Boats	1-hole	\$40
RRLS9012	\$1.50 Surf Boats	Used	\$35
RRLS9013	\$3.00 Zodiac	Mint	\$15
RRLS9014	\$3.00 Zodiac	1-hole	\$15
RRLS9015	\$3.00 Zodiac	Used	\$10
RRLS9016	\$6.00 Surf Crew	Mint	\$70
RRLS9017	\$6.00 Surf Crew	1-hole	\$65
RRLS9018	\$6.00 Surf Crew	Used	\$60
RRPS 9019 Collectors Pack				\$240

South Australia

RRLS9020	\$2.00 Vineyard	Mint	\$35
RRLS9021	\$2.00 Vineyard	1-hole	\$20
RRLS9022	\$2.00 Vineyard	Used	\$6
RRLS9023	\$2.00 River Murray	Mint	\$45
RRLS9024	\$2.00 River Murray	1-hole	\$40
RRLS9025	\$2.00 River Murray	Used	\$20
RRLS9026	\$5.00 Adelaide Grand Prix	Mint	\$45
RRLS9027	\$5.00 Adelaide Grand Prix	1-hole	\$15
RRLS9028	\$5.00 Adelaide Grand Prix	Used	\$10
RRLC9029	\$5.00 Flinders Ranges	Mint	\$45
RRLC9030	\$5.00 Flinders Ranges	1-hole	\$20
RRLC9031	\$5.00 Flinders Ranges	Used	\$15
RRLS9032	\$10.00 Kangaroo Island	Mint	\$75
RRLS9033	\$10.00 Kangaroo Island	1-hole	\$60
RRLS9034	\$10.00 Kangaroo Island	Used	\$35
RRLA9035	\$20.00 Adelaide City	Mint	\$180
RRLA9036	\$20.00 Adelaide City	1-hole	\$30
RRLA9037	\$20.00 Adelaide City	Used	\$15
RRPL9038 Collectors Pack				\$500

Generic

RRL-9039	\$2 Logo	Mint	\$5
RRL-9040	\$2 Logo	1-hole	\$3
RRL-9041	\$2 Logo	Used	\$1
RRL-9042	\$5 Logo	Mint	\$45
RRL-9043	\$5 Logo	1-hole	\$15
RRL-9044	\$5 Logo	Used	\$6
RRL-9045	\$10 Logo	Mint	\$195
RRL-9046	\$10 Logo	1-hole	\$12
RRL-9047	\$10 Logo	Used	\$6
RRL-9048	\$20 Logo	Mint	\$75
RRL-9049	\$20 Logo	1-hole	\$25
RRL-9050	\$20 Logo	Used	\$6
RRL-9051	\$50 Logo	Mint	\$70
RRL-9052	\$50 Logo	1-hole	\$45
RRL-9053	\$50 Logo	Used	\$20
RRP-9054 \$5 Collectors Pack				\$120

Grand Prix

RRLC9055	\$5.00 Alfa and Wreath	Mint	\$60
RRLC9056	\$5.00 Alfa and Wreath	1-hole	\$30
RRLC9057	\$5.00 Alfa and Wreath	Used	\$15
RRPL9058 Collectors Pack				\$80

Queensland

RRLS9059	\$5.00 Barrier Reef	Mint	\$20
RRLS9060	\$5.00 Barrier Reef	1-hole	\$15
RRLS9061	\$5.00 Barrier Reef	Used	\$10
RRLS9062	\$5.00 Gold Coast	Mint	\$20
RRLS9063	\$5.00 Gold Coast	1-hole	\$20
RRLS9064	\$5.00 Gold Coast	Used	\$20
RRLS9065	\$10.00 Brisbane City	Mint	\$195
RRLS9066	\$10.00 Brisbane City	1-hole	\$100
RRLS9067	\$10.00 Brisbane City	Used	\$65
RRPL9068 Collectors Pack				\$280

Victoria

RRLS9069	\$5.00 Melbourne City	Mint	\$20
RRLS9070	\$5.00 Melbourne City	1-hole	\$10
RRLS9071	\$5.00 Melbourne City	Used	\$4
RRLS9072	\$5.00 River Murray	Mint	\$25
RRLS9073	\$5.00 River Murray	1-hole	\$12
RRLS9074	\$5.00 River Murray	Used	\$4

RRLS9075	\$10.00 Grampians	Mint	\$60
RRLS9076	\$10.00 Grampians	1-hole	\$15
RRLS9077	\$10.00 Grampians	Used	\$6
RRLS9078 Collectors Pack				\$400

New South Wales

RRLA9079	\$2.00 Orang-utan	Mint	\$15
RRLA9080	\$2.00 Orang-utan	1-hole	\$3
RRLA9081	\$2.00 Orang-utan	Used	\$2
RRLA9082	\$2.00 Echidna	Mint	\$20
RRLA9083	\$2.00 Echidna	1-hole	\$4
RRLA9084	\$2.00 Echidna	Used	\$3
RRLA9085	\$5.00 Platypus	Mint	\$30
RRLA9086	\$5.00 Platypus	1-hole	\$28
RRLA9087	\$5.00 Platypus	Used	\$25
RRLA9088	\$5.00 Giraffe	Mint	\$50
RRLA9089	\$5.00 Giraffe	1-hole	\$25
RRLA9090	\$5.00 Giraffe	Used	\$15
RRLA9091	\$10.00 Cheetah	Mint	\$250
RRLA9092	\$10.00 Cheetah	1-hole	\$15
RRLA9093	\$10.00 Cheetah	Used	\$8
RRLA9094	\$20.00 Zoo Entrance	Mint	\$60
RRLA9095	\$20.00 Zoo Entrance	1-hole	\$45
RRLA9096	\$20.00 Zoo Entrance	Used	\$20
RRPA9097 Collectors Pack				\$650

Australian Capital Territory

RRLS9098	\$2.00 Royal Mint	Mint	\$20
RRLS9099	\$2.00 Royal Mint	1-hole	\$18
RRLS9100	\$2.00 Royal Mint	Used	\$10
RRLS9101	\$2.00 Canberra View	Mint	\$40
RRLS9102	\$2.00 Canberra View	1-hole	\$35
RRLS9103	\$2.00 Canberra View	Used	\$20
RRLS9104	\$5.00 Questacon	Mint	\$15
RRLS9105	\$5.00 Questacon	1-hole	\$15
RRLS9106	\$5.00 Questacon	Used	\$10
RRLS9107	\$5.00 War Memorial	Mint	\$40
RRLS9108	\$5.00 War Memorial	1-hole	\$35
RRLS9109	\$5.00 War Memorial	Used	\$20
RRLS9110	\$10.00 Telecom Tower	Mint	\$150
RRLS9111	\$10.00 Telecom Tower	1-hole	\$60
RRLS9112	\$10.00 Telecom Tower	Used	\$30
RRPL9113 Collectors Pack				\$300

Western Australia

RRLS9114	\$2.00 Perth Skyline	Mint	\$25
RRLS9115	\$2.00 Perth Skyline	1-hole	\$25
RRLS9116	\$2.00 Perth Skyline	Used	\$20
RRLS9117	\$5.00 Karri Forest	Mint	\$25
RRLS9118	\$5.00 Karri Forest	1-hole	\$25
RRLS9119	\$5.00 Karri Forest	Used	\$20
RRLS9120	\$10.00 Bungle Bungles	Mint	\$30
RRLS9121	\$10.00 Bungle Bungles	1-hole	\$30
RRLS9122	\$10.00 Bungle Bungles	Used	\$25
RRPL9123 Collectors Pack				\$80

Northern Territory

RRLA9124	\$5.00 Crocodile	Mint	\$25
RRLA9125	\$5.00 Crocodile	1-hole	\$25
RRLA9126	\$5.00 Crocodile	Used	\$20
RRLA9127	\$5.00 Ayers Rock	Mint	\$45
RRLA9128	\$5.00 Ayers Rock	1-hole	\$45
RRLA9129	\$5.00 Ayers Rock	Used	\$40
RRPL9130 Collectors Pack				\$65

Tasmania

RRLS9131	\$2.00 Cradle Mountain	Mint	\$40
RRLS9132	\$2.00 Cradle Mountain	1-hole	\$40
RRLS9133	\$2.00 Cradle Mountain	Used	\$30
RRLS9134	\$5.00 Hunter Street	Mint	\$25
RRLS9135	\$5.00 Hunter Street	1-hole	\$25
RRLS9136	\$5.00 Hunter Street	Used	\$20
RRPL9137 Collectors Pack				\$65

Geneva Conference

RRLA9138	\$5.00 Koala	Mint	\$190
RRLA9139	\$5.00 Koala	1-hole	\$150
RRLA9140	\$5.00 Koala	Used	\$140
RRPA9141 Folder (only sold at Exhibition)				\$700

Red Cross

RRLQ9142	\$2.00 Health & Safety	Mint	\$15
RRLQ9143	\$2.00 Health & Safety	1-hole	\$15
RRLQ9144	\$2.00 Health & Safety	Used	\$4
RRLQ9145	\$2.00 Blood Transfusion	Mint	\$35

RRLQ9146	\$2.00 Blood Transfusion	1-hole	\$25
RRLQ9147	\$2.00 Blood Transfusion	Used	\$15
RRLQ9148	\$5.00 Community Service	Mint	\$30
RRLQ9149	\$5.00 Community Service	1-hole	\$15
RRLQ9150	\$5.00 Community Service	Used	\$3
RRLQ9151	\$5.00 Youth	Mint	\$30
RRLQ9152	\$5.00 Youth	1-hole	\$15
RRLQ9153	\$5.00 Youth	Used	\$3
RRLQ9154	\$10.00 Disaster Relief	Mint	\$60
RRLQ9155	\$10.00 Disaster Relief	1-hole	\$8
RRLQ9156	\$10.00 Disaster Relief	Used	\$3
RRLQ9157	\$20.00 Assignments	Mint	\$60
RRLQ9158	\$20.00 Assignments	1-hole	\$20
RRLQ9159	\$20.00 Assignments	Used	\$10
RRPQ9160 Collectors Pack				\$320

Australia Day 1992

RRLQ9161	\$5.00 Abstract	Mint	\$45
RRLQ9162	\$5.00 Abstract	1-hole	\$35
RRLQ9163	\$5.00 Abstract	Used	\$20
RRPQ9164 Collectors Pack				\$90

Olympic Games

RRLS9165	\$2.00 Hockey	Mint	\$65
RRLS9166	\$2.00 Hockey	1-hole	\$25
RRLS9167	\$2.00 Hockey	Used	\$8
RRLS9168	\$5.00 Willy	Mint	\$50
RRLS9169	\$5.00 Willy	1-hole	\$15
RRLS9170	\$5.00 Willy	Used	\$8
RRLS9171	\$5.00 Swimming	Mint	\$30
RRLS9172	\$5.00 Swimming	1-hole	\$3
RRLS9173	\$5.00 Swimming	Used	\$1
RRLS9174	\$5.00 Cycling	Mint	\$30
RRLS9175	\$5.00 Cycling	1-hole	\$3
RRLS9176	\$5.00 Cycling	Used	\$1
RRLS9177	\$10.00 Track & Field	Mint	\$30
RRLS9178	\$10.00 Track & Field	1-hole	\$3
RRLS9179	\$10.00 Track & Field	Used	\$1
RRLS9180	\$20.00 Marathon	Mint	\$45
RRLS9181	\$20.00 Marathon	1-hole	\$15
RRLS9182	\$20.00 Marathon	Used	\$8
RRPS9183 Collectors Pack				\$350

Telecom Advertising 1992

RRLK9184	\$5.00 Messages	Mint	\$12
RRLK9185	\$5.00 Messages	1-hole	\$2
RRLK9186	\$5.00 Messages	Used	\$1
RRLK9187	\$5.00 Hit a Snag	Mint	\$15
RRLK9188	\$5.00 Hit a Snag	1-hole	\$3
RRLK9189	\$5.00 Hit a Snag	Used	\$2
RRLK9190	\$10.00 Turn up Volume	Mint	\$25
RRLK9191	\$10.00 Turn up Volume	1-hole	\$2
RRLK9192	\$10.00 Turn up Volume	Used	\$1
RRLK9193	\$20.00 Don't Hang Around	Mint	\$40
RRLK9194	\$20.00 Don't Hang Around	1-hole	\$15
RRLK9195	\$20.00 Don't Hang Around	Used	\$8

Christmas 1992

RRLN9196	\$1.50 Bird Choir*	Mint	\$200
RRLN9197	\$1.50 Bird Choir*	1-hole	\$200
RRLN9198	\$1.50 Bird Choir*	Used	\$175
RRLN9199	\$5.00 Wombats on Beach	Mint	\$15
RRLN9200	\$5.00 Wombats on Beach	1-hole	\$3
RRLN9201	\$5.00 Wombats on Beach	Used	\$2
RRLN9202	\$10.00 Koala Santa Claus	Mint	\$60
RRLN9203	\$10.00 Koala Santa Claus	1-hole	\$5
RRLN9204	\$10.00 Koala Santa Claus	Used	\$3
	* in Telecom Greeting Card folder			

Australia Day 1993

RRLN9205	\$5.00 Happy Faces	Mint	\$60
RRLN9206	\$5.00 Happy Faces	1-hole	\$5
RRLN9207	\$5.00 Happy Faces	Used	\$2
RRLP9208 Collectors Pack				\$45

Telecom Generic - Tourism (Old Logo)

RRLS9209	\$5.00 Opera House	Mint	\$10
RRLS9210	\$5.00 Opera House	1-hole	\$2
RRLS9211	\$5.00 Opera House	Used	\$1
RRLA9212	\$10.00 Kangaroo	Mint	\$20
RRLA9213	\$10.00 Kangaroo	1-hole	\$3
RRLA9214	\$10.00 Kangaroo	Used	\$1
RRLA9215	\$20.00 Great Barrier Reef	Mint	\$30
RRLA9216	\$20.00 Great Barrier Reef	1-hole	\$5
RRLA9217	\$20.00 Great Barrier Reef	Used	\$2
RRLA9218	\$50.00 Koala	Mint	\$120
RRLA9219	\$50.00 Koala	1-hole	\$75
RRLA9220	\$50.00 Koala	Used	\$40

RRLQ9239 \$20.00 Eternity Used \$10
 RRPL9240 Collectors Pack \$45

Advertising Cards 1993

RRLQ9241 \$5.00 KMart-AC Cola Mint \$8
 RRLQ9242 \$5.00 KMart-AC Cola 1-hole \$8
 RRLQ9243 \$5.00 KMart-AC Cola Used \$6
 RRLV9244 \$10.00 KMart-Camping Mint \$14
 RRLV9245 \$10.00 KMart-Camping 1-hole \$12
 RRLV9246 \$10.00 KMart-Camping Used \$8
 RRLV9247 \$20.00 KMart-Clothing Mint \$25
 RRLV9248 \$20.00 KMart-Clothing 1-hole \$20
 RRLV9249 \$20.00 KMart-Clothing Used \$12
 RRLA9250 \$10.00 XXXX-Beer Mint \$14
 RRLA9251 \$10.00 XXXX-Beer 1-hole \$12
 RRLA9252 \$10.00 XXXX-Beer Used \$8

Landscapes 1993

RRL9253 \$5.00 Kakadu Billabong Mint \$7
 RRL9254 \$5.00 Kakadu Billabong 1-hole \$2
 RRL9255 \$5.00 Kakadu Billabong Used \$1
 RRL9256 \$10.00 Lizard Island Mint \$12
 RRL9257 \$10.00 Lizard Island 1-hole \$5
 RRL9258 \$10.00 Lizard Island Used \$3
 RRL9259 \$20.00 Northern Flinders Mint \$25
 RRL9260 \$20.00 Northern Flinders 1 hole \$15
 RRL9261 \$20.00 Northern Flinders Used \$6
 RRPL9262 Collectors Pack \$45

Sydney Olympic Bid 2000

RRLS9263 \$5.00 Olympic Bid Logo Mint \$25
 RRLS9264 \$5.00 Olympic Bid Logo 1-hole \$15
 RRLS9265 \$5.00 Olympic Bid Logo Used \$8

Microscopy (Micro-Photographs)

RRLQ9266 \$5.00 Marine Plankton Mint \$7
 RRLQ9267 \$5.00 Marine Plankton 1-hole \$2
 RRLQ9268 \$5.00 Marine Plankton Used \$1
 RRLQ9269 \$10.00 Butterfly Eggs Mint \$12
 RRLQ9270 \$10.00 Butterfly Eggs 1-hole \$5
 RRLQ9271 \$10.00 Butterfly Eggs Used \$3
 RRLQ9272 \$20.00 Pollen Grains Mint \$25
 RRLQ9273 \$20.00 Pollen Grains 1 hole \$15
 RRLQ9274 \$20.00 Pollen Grains Used \$8
 RRPQ9275 Collectors Pack \$70

Telecom Generic (New Logo)

RRL9276 \$5.00 Opera House Mint \$8
 RRL9277 \$5.00 Opera House 1 hole \$2
 RRL9278 \$5.00 Opera House Used \$1
 RRLA9279 \$10.00 Kangaroo Mint \$25
 RRLA9280 \$10.00 Kangaroo 1-hole \$2
 RRLA9281 \$10.00 Kangaroo Used \$1
 RRLA9282 \$20.00 Great Barrier Reef Mint \$30
 RRLA9283 \$20.00 Great Barrier Reef 1-hole \$6
 RRLA9284 \$20.00 Great Barrier Reef Used \$2
 RRLA9285 \$50.00 Koala Mint \$80
 RRLA9286 \$50.00 Koala 1-hole \$40
 RRLA9287 \$50.00 Koala Used \$25

Environment Protection

RRLQ9288 \$5.00 Recycle Mint \$7
 RRLQ9289 \$5.00 Recycle 1-hole \$3
 RRLQ9290 \$5.00 Recycle Used \$2
 RRLQ9291 \$10.00 Plant a Tree Mint \$12
 RRLQ9292 \$10.00 Plant a Tree 1-hole \$5
 RRLQ9293 \$10.00 Plant a Tree Used \$3
 RRLQ9294 \$20.00 Green Consumer Mint \$25
 RRLQ9295 \$20.00 Green Consumer 1-hole \$6
 RRLQ9296 \$20.00 Green Consumer Used \$3
 RRPL9297 Collectors Pack \$60

Christmas 1993

RRLN9298 \$5.00 Outback Christmas Mint \$10
 RRLN9299 \$5.00 Outback Christmas 1-hole \$3
 RRLN9300 \$5.00 Outback Christmas Used \$2
 RRLN9301 \$10.00 City Christmas Mint \$20
 RRLN9302 \$10.00 City Christmas 1 hole \$5
 RRLN9303 \$10.00 City Christmas Used \$3

Australia Day 1994

RRLQ9304 \$5.00 Abstract Design Mint \$15
 RRLQ9305 \$5.00 Abstract Design 1 Hole \$3
 RRLQ9306 \$5.00 Abstract Design Used \$2
 RRPQ9307 Collectors Pack \$65

Australian Dinosaurs

RRLA9308 \$5.00 Muttaborrasaurus Mint \$7
 RRLA9309 \$5.00 Muttaborrasaurus 1-hole \$2
 RRLA9310 \$5.00 Muttaborrasaurus Used \$1
 RRLA9311 \$10.00 Austrosaurus Mint \$12
 RRLA9312 \$10.00 Austrosaurus 1-hole \$4
 RRLA9313 \$10.00 Austrosaurus Used \$2
 RRLA9314 \$20.00 Mimmi Mint \$25
 RRLA9315 \$20.00 Mimmi 1 hole \$15
 RRLA9316 \$20.00 Mimmi Used \$7
 RRPA9317 Collectors Pack \$120

Year of the Dog

RRLN9318 \$5.00 Dog on Ball Mint \$8
 RRLN9319 \$5.00 Dog on Ball 1-hole \$8
 RRLN9320 \$5.00 Dog on Ball Used \$5
 RRLN9321 \$5.00 Dog on Unicorn Mint \$8
 RRLN9322 \$5.00 Dog on Unicorn 1-hole \$8
 RRLN9323 \$5.00 Dog on Unicorn Used \$5
 RRLN9324 \$5.00 Dog and Flowers Mint \$8
 RRLN9325 \$5.00 Dog and Flowers 1-hole \$8
 RRLN9326 \$5.00 Dog and Flowers Used \$5
 RRLN9327 \$5.00 Dog and Flowers Mint \$8
 RRLN9328 \$5.00 Dog and Ribbon 1-hole \$8
 RRLN9329 \$5.00 Dog and Ribbon

RRLN9330 \$5.00 Dog and Ribbon Used \$5
 RKPA0079 Collectors Pack \$60

Endangered Species/WWF

RRLA9331 \$5.00 Bilby Mint \$7
 RRLA9332 \$5.00 Bilby 1-hole \$2
 RRLA9333 \$5.00 Bilby Used \$1
 RRLA9334 \$10.00 Swamp Turtle Mint \$12
 RRLA9335 \$10.00 Swamp Turtle 1-hole \$3
 RRLA9336 \$10.00 Swamp Turtle Used \$1
 RRLA9337 \$20.00 Gouldian Finch Mint \$25
 RRLA9338 \$20.00 Gouldian Finch 1-hole \$15
 RRLA9339 \$20.00 Gouldian Finch Used \$8
 RRPA9340 Collectors Pack \$90

Landscapes 1994

RRL9341 \$5.00 Bollard's Lagoon Mint \$8
 RRL9342 \$5.00 Bollard's Lagoon 1-hole \$7
 RRL9343 \$5.00 Bollard's Lagoon Used \$4
 RRL9344 \$5.00 Lamington Park Mint \$8
 RRL9345 \$5.00 Lamington Park 1 hole \$7
 RRL9346 \$5.00 Lamington Park Used \$4
 RRL9347 \$5.00 E Alligator River Mint \$8
 RRL9348 \$5.00 E Alligator River 1-hole \$7
 RRL9349 \$5.00 E Alligator River Used \$4
 RRL9350 \$5.00 The Pinnacles Mint \$8
 RRL9351 \$5.00 The Pinnacles 1-hole \$7
 RRL9352 \$5.00 The Pinnacles Used \$4
 RRL9353 \$5.00 Mt. Ben Lomond Mint \$8
 RRL9354 \$5.00 Mt. Ben Lomond 1-hole \$7
 RRL9355 \$5.00 Mt. Ben Lomond Used \$4
 RRL9356 \$10.00 Mt. Hotham Mint \$12
 RRL9357 \$10.00 Mt. Hotham 1-hole \$2
 RRL9358 \$10.00 Mt. Hotham Used \$1
 RRL9359 \$20.00 Crescent Head Mint \$25
 RRL9360 \$20.00 Crescent Head 1-hole \$8
 RRL9361 \$20.00 Crescent Head Used \$4
 RRPL9362 Collectors Pack \$75

Dance/Ballet

RRLQ9363 \$5.00 Ballet Mint \$7
 RRLQ9364 \$5.00 Ballet 1-hole \$2
 RRLQ9365 \$5.00 Ballet Used \$1
 RRLQ9366 \$5.00 Dance Mint \$7
 RRLQ9367 \$5.00 Dance 1-hole \$2
 RRLQ9368 \$5.00 Dance Used \$1
 RRLQ9369 \$10.00 Dance Mint \$12
 RRLQ9370 \$10.00 Dance 1-hole \$3
 RRLQ9371 \$20.00 Ballet Mint \$25
 RRLQ9372 \$20.00 Ballet 1-hole \$8
 RRLQ9373 \$20.00 Ballet Used \$4

Commonwealth Games

RRLS9374 \$5.00 Diving Mint \$7
 RRLS9375 \$5.00 Diving 1-Hole \$2
 RRLS9376 \$5.00 Diving Used \$1
 RRLS9377 \$5.00 Cycling Mint \$7
 RRLS9378 \$5.00 Cycling 1-hole \$2
 RRLS9379 \$5.00 Cycling Used \$1
 RRLS9380 \$10.00 Shot Put Mint \$12
 RRLS9381 \$10.00 Shot Put 1-hole \$3
 RRLS9382 \$10.00 Shot Put Used \$2
 RRP9383 Collectors Pack \$70

Toyota

RRLC9384 \$5.00 New Corolla Mint \$10
 RRLC9385 \$5.00 New Corolla 1-hole \$8
 RRLC9386 \$5.00 New Corolla Used \$6

CARDEX 94

RRL9387 Australian Flowers Mint \$10
 RRL9388 Australian Flowers 1-hole \$8
 RRL9389 Australian Flowers Used \$6
 RRP9390 Folder (only sold at exhibition) \$80

Social Security

RRLU9391 \$4.00 Payphone Booth Mint \$10
 RRLU9392 \$4.00 Payphone Booth 1-hole \$2
 RRLU9393 \$4.00 Payphone Booth Used \$1

Surf Life Saving

RRLS9394 \$5.00 Underwater Mint \$7
 RRLS9395 \$5.00 Underwater 1-hole \$2
 RRLS9396 \$5.00 Underwater Used \$1
 RRLS9397 \$5.00 Surf Rescue Mint \$7
 RRLS9398 \$5.00 Surf Rescue 1-hole \$2
 RRLS9399 \$5.00 Surf Rescue Used \$1
 RRLS9400 \$10.00 Life Saving History Mint \$12
 RRLS9401 \$10.00 Life Saving History 1-hole \$2
 RRLS9402 \$10.00 Life Saving History Used \$1
 RRLS9403 \$20.00 Boat Rescue Mint \$25
 RRLS9404 \$20.00 Boat Rescue 1-hole \$15
 RRLS9405 \$20.00 Boat Rescue Used \$10
 RRP9406 Collectors Pack \$50

Christmas 1994

RRLS9407 \$5 Drawing Mint \$7
 RRLS9408 \$5 Drawing 1-hole \$2
 RRLS9409 \$5 Drawing Used \$1
 RRLN9410 \$10 Drawing Mint \$12
 RRLN9411 \$10 Drawing 1-Hole \$2
 RRLN9412 \$10 Drawing Used \$1
 RRLN9413 \$20 Drawing Mint \$25
 RRLN9414 \$20 Drawing 1-hole \$5
 RRLN9415 \$20 Drawing Used \$3
 RRPN9416 Collectors Pack \$45

Bookmuncher

RRLK9417 \$5.00 Bookmuncher Mint \$7

RRLK9418 \$5.00 Bookmuncher 1 hole \$2
 RRLK9419 \$5.00 Bookmuncher Used \$1
 RRLK9420 \$10.00 Bookmuncher Mint \$12
 RRLK9421 \$10.00 Bookmuncher 1 hole \$2
 RRLK9422 \$10.00 Bookmuncher Used \$1
 RRLK9423 \$20.00 Bookmuncher Mint \$25
 RRLK9424 \$20.00 Bookmuncher 1 hole \$5
 RRLK9425 \$20.00 Bookmuncher Used \$3

Newsagents Association

RRLV9426 \$5.00 Newspaper Titles Mint \$7
 RRLV9427 \$5.00 Newspaper Titles 1 hole \$2
 RRLV9428 \$5.00 Newspaper Titles Used \$1

Australia Day 1995

RRLQ9429 \$5.00 Children's Faces Mint \$7
 RRLQ9430 \$5.00 Children's Faces 1 hole \$2
 RRLQ9431 \$5.00 Children's Faces Used \$1
 RRPQ9429 Collectors Pack \$16

Specialist Material

1994 Landscape series

\$5 #448 Mount Ben Lomond \$12
 \$5 #448 Bollards Lagoon \$13
 \$5 #449 Mount Ben Lomond \$12
 \$5 #449 Lamington Nat. Park \$8
 \$5 #449 Bollards Lagoon \$12
 \$5 #449 East Alligator River \$12
 \$5 #449 The Pinnacles \$12
 \$5 #450 Mount Ben Lomond \$12
 \$5 #450 East Alligator River \$12
 \$5 #450 Bollards Lagoon \$12
 \$5 #450 Lamington Nat. Park \$12
 \$5 #451 The Pinnacles \$10
 \$5 #451 Mount Ben Lomond \$8
 \$5 #452 Lamington Nat. Park \$12
 \$5 #452 Mount Ben Lomond \$12
 \$5 #452 East Alligator River \$8
 \$5 #452 The Pinnacles \$8
 \$5 #452 Bollards Lagoon \$8

Consecutive Pairs

The Dance/Ballet, Commonwealth Games and Surf Lifesaving \$5 cards can be found in "consecutive pairs", ie, 2 different picture cards with consecutive numbers. Only a few such pairs exist for every 1000 cards printed, and we are able to offer some of these due to the diligent searching of a number of collectors.

Commonwealth Games 1994

- Consecutive pairs of the \$5 values
 Prefix 503 \$20
 Prefix 504 \$20
 Prefix 506 \$20
 Prefix 507 \$20
 Prefix 509 \$20
 Prefix 510 \$20

Surf Life Saving 1994

- Complete set of the 15 prefix number pairs comprising 529 to 536 inclusive, 573 to 577 inclusive, 601 and 602. A difficult assembly \$270
 All above prefix numbers are available separately in pairs at, each \$20

Specimen Set (BP, Mobil [both], Geneva)

6 cards, genuine Telecom Specimens \$195

Status Retail
 PO Box A2176, Sydney
 South, NSW 2000,
 Australia

☎ (02) 267 6116 Fax (02) 267 6124

Postage & Packing:

Certified in Australia \$2 (loose cards only); \$4 (up to 5 folders); Overseas Registered Airmail: min AS12 (loose cards); AS15 (up to 3 folders); Ordinary Airmail (your risk) AS2 (loose cards); AS4 (up to 3 folders).

Larger orders at our cost.

All prices are subject to change due to market fluctuations, but we will endeavour to supply at prices quoted for as long as possible.

Australian Custom Cards

(our comprehensive listing to date)

RKPR0001	Tamworth Country Music Festival (set of 2) mint in collectors pack	MUSIC	\$70.00
RKLR0002	Tamworth Country Music Festival (set of 2) mint cards	MUSIC	\$65.00
RKPF0003	Swiss Chocolate Bars Players Biscuits mint in collectors pack	FOOD	\$45.00
RKLF0004	Swiss Chocolate Bars Players Biscuits mint cards	FOOD	\$35.00
RKPL0005	Ettamogah Pub (Aust Theme bar) mint in collectors pack	BUILDING	\$50.00
RKLL0006	Ettamogah Pub (Aust Theme bar) mint card	BUILDING	\$40.00
RKPQ0007	Museum of Contemporary Art (\$2 card and \$20 Warhol) mint in collectors pack	ARTS	\$75.00
RKLQ0008	Museum of Contemporary Art and Harbour Bridge mint \$2 card	ARTS	\$12.00
RKPL0009	Opera House photographs (set of 3) mint in collectors pack	BUILDING	\$70.00
RKLL0010	Opera House photographs (set of 3) mint cards in wallet	BUILDING	\$65.00
RKPS0011	Aust Football League players: Gary Ablett mint in collectors pack	SPORTS	\$25.00
RKUS0012	Aust Football League players: Gary Ablett pack and mint loose card	SPORTS	\$35.00
RKPS0013	Aust Football League players: Tony Modra mint in collectors pack	SPORTS	\$19.50
RKUS0014	Aust Football League players: Tony Modra pack and mint loose card	SPORTS	\$29.95
RKPS0015	Aust Football League players: Stephen Silvagni mint in collectors pack	SPORTS	\$19.50
RKUS0016	Aust Football League players: Stephen Silvagni pack and loose mint card	SPORTS	\$29.95
RKPS0017	Aust Football League players: Chris Mainwarring mint in collectors pack	SPORTS	\$19.50
RKUS0018	Aust Football League players: Chris Mainwarring pack and loose mint card	SPORTS	\$29.95
CKLH0019	The Phonecard Collector mint card (with FREE subscription in Aust)	MAGAZINES	\$43.95
RKPP0020	Apollo 11 Moonlanding (set of 5) mint in collectors pack	SPACE	\$295.00
RKPP0021	Apollo 11 Moonlanding Conference (\$10 and \$20) mint in collectors pack	SPACE	\$95.00
RKLP0022	Apollo 11 Moonlanding short set (\$2, \$5 and \$10) mint cards	SPACE	\$50.00
RKLP0023	Apollo 11 Moonlanding single \$2 mint card	SPACE	\$15.00
RKPP0024	Apollo 15 (set of 5 - \$2, \$5, \$10, \$20 and \$50) mint in collectors pack	SPACE	\$215.00
RKLP0025	Apollo 15 short set (\$2, \$5, \$10 and \$20) mint cards	SPACE	\$85.00
RKLP0026	Apollo 15 \$20 planting flag on Moon mint card	SPACE	\$40.00
RKLP0027	Apollo 15 \$10 Moon buggy mint card	SPACE	\$20.00
RKLP0028	Apollo 15 \$5 Capsule splash-down mint card	SPACE	\$15.00
RKPL0029	Albury High School fundraiser mint in collectors pack	BUILDING	\$30.00
RKLL0030	Albury High School fundraiser mint card	BUILDING	\$15.00
RKPA0031	Australian Wildlife Fund Koala mint in collectors pack with \$20 stamps	ANIMALS	\$25.00
RKFA0032	Australian Wildlife Fund Koala Folio collectors edition (1,000) pack	ANIMALS	\$140.00
RKPA0033	Australian Wildlife Fund Duck mint in collectors pack with \$40 stamps	ANIMALS	\$49.00
RKFA0034	Australian Wildlife Fund Duck Folio collectors edition (1,000) pack	ANIMALS	\$95.00
RKPT0035	Railway Historical Society 1210 Locomotive (restored) mint in collectors pack	TRAINS	\$25.00
RKPL0036	Courage Under Fire (set of 2) mint in collectors pack	NATURE	\$39.00
RKLL0037	Courage Under Fire (set of 2) mint cards	NATURE	\$25.00
RKUL0038	Courage Under Fire collectors pack and mint cards together	NATURE	\$60.00
RKLP0039	VST 30th Anniversary mint card (view of earth) and FREE catalogue	SPACE	\$10.00
RKPC0040	Spies Hecker Sportscars and Girls (set of 3) mint in collectors pack	CARS/GIRLS	\$60.00
RKPY0041	ASDA Western Australia "inverted Swan" stamp mint in collectors pack	STAMPS	\$24.00
RKPA0042	Animal Eyes (set of 4 \$50 cards) mint in collectors pack (2,500 only)	ANIMALS	\$335.00
RKPL0043	Black Opal (stone) mint in collectors pack	NATURE	\$34.00
RKLL0044	Black Opal (stone) mint card	NATURE	\$26.00
RKUL0045	Black Opal (stone) collectors pack and mint card together	NATURE	\$55.00
RKPL0046	National Parks and Wildlife views (set of 15) mint in collectors pack	NATURE	\$120.00
RKPA0047	Zoo Series (matches new stamps, set of 2) pack incl. stamps	STAMPS/ANIMALS	\$35.00
RKUA0048	Zoo Series set of 4 collectors packs above showing each zoo	STAMPS/ANIMALS	\$130.00
RKLA0049	Zoo Series (set of 2) mint cards	ANIMALS	\$25.00
RKPC0050	Rally Australia (set of 3) showing cars & winners mint in collectors pack	CARS/SPORTS	\$60.00

RKPL0051	Fingal Post Office historic building mint in collectors pack	BUILDING	\$14.00
RKLQ0052	Reflections of China's history & culture (set of 5) mint cards	CULTURE	\$65.00
RKPL0053	Lloyd Rees watercolour of Opera House with print mint in collectors pack	BUILDING	\$60.00
RKLL0054	Lloyd Rees watercolour of Opera House (\$20) mint card	BUILDING	\$40.00
RKUL0055	Lloyd Rees watercolour of Opera House pack and mint card together	BUILDING	\$95.00
RKPL0056	Summertime typical Aust beach scene (i) mint in collectors pack	LANDSCAPE	\$10.00
RKLL0057	Summertime typical Aust beach scene (i) mint card	LANDSCAPE	\$6.00
RKPL0058	Summertime typical Aust beach scene (ii) mint in collectors pack	LANDSCAPE	\$10.00
RKLL0059	Summertime typical Aust beach scene (ii) mint card	LANDSCAPE	\$6.00
RKPH0060	War Memorial World War II commemoration (set of 5) mint in pack	HISTORY	\$75.00
RKPS0061	One Australia America's Cup challenge (set of 4) mint in pack (available February 1995)	BOATS/SPORTS	\$99.95
RKPQ0062	Bell Shakespeare Company performances (set of 4) mint in pack	ARTS	on hold
CKPD0063	Disney Australia - Mickey and Donald down under (set of 2) in pack	DISNEY	\$35.00
CKPS0064	Michael Lynagh Australian Wallabies Rugby Union Captain mint in collector pack	SPORTS	\$19.50
CKUS0065	Captains of Rugby (Lynagh and Fitzpatrick - on NZ advert card) mint in pack	SPORTS	\$39.50
RKPZ0066	Coca-Cola Australia Santa Claus mint in pack	COKE	\$25.00
RKPZ0067	Coca-Cola Australia Polar Bear mint in pack	COKE	\$25.00
RKPW0068	Endeavour replica voyage (set of 4) mint in pack	SHIPPING	on hold
RKPW0069	Solo Round the World Yacht Race (set of 3) mint in pack (available Feb 1995)	BOATS	on hold
RKPV0070	Dial A Box removals complimentary \$2 card mint in pack	BRANDS	\$20.00
RKPC0071	Simpsons family scene mint in collectors pack	COMICS	\$24.00
RKCC0072	Simpsons family scene mint \$5 card	COMICS	\$18.00
RKPC0073	Flintstones family scene in car mint in collectors pack	COMICS	\$24.00
RKLC0074	Flintstones family scene in car mint \$5 card	COMICS	\$18.00
RKPM0075	Luna Park re-opening entrance mint in collectors pack	ENTERTAINMENT	\$24.00
RKPL0076	Luna Park re-opening mint \$5 card	ENTERTAINMENT	\$18.00
RKPT0077	Thirlmere Railway locomotive \$5 card in collectors pack with 2 local stamp miniature sheets	TRAINS	\$25.00
RKPA0080	Kookaburra mint in collectors pack	BIRDS	\$19.50
RKLA0081	Kookaburra mint \$5 card	BIRDS	\$12.00
RKUA0082	Combination Kookaburra pack and loose card	BIRDS	\$29.50

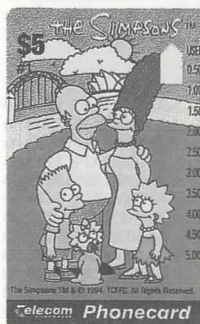

Simpsons
mint card \$18
pack \$24



Flintstones
mint card \$18
pack \$24



Michael Lynagh

Australian Wallabies Rugby Union
Captain mint in collector pack \$19.50

Captains of Rugby (Lynagh and Fitzpatrick
- on NZ advert card) mint in pack \$39.50

Status Retail

PO Box A2176, Sydney South, NSW 2000, Australia

☎ (02) 267 6116 Fax (02) 267 6124

Postage & Packing: Certified in Australia \$2 (loose cards only); \$4 (up to 5 folders); Overseas Registered Airmail: min A\$12 (loose cards); A\$15 (up to 3 folders); Ordinary Airmail (your risk) A\$2 (loose cards); A\$4 (up to 3 folders). Larger orders at our cost.

PAYTEL AUSTRALIA

RPLL0600	Abel Tasman (trial issue) set (3) mint	LANDSCAPE \$175.00
RPPL0601	Abel Tasman (trial issue) collectors pack (1,500)	LANDSCAPE \$225.00
RPLW0602	Spirit of Tasmania set (3) mint	SHIPPING \$65.00
RPPW0603	Spirit of Tasmania collectors pack (2,500)	SHIPPING \$70.00
RPLL0604	Wilderness Rivers set (3) mint	LANDSCAPE \$40.00
RPLP0605	Wilderness Rivers collectors pack (2,500)	LANDSCAPE \$45.00
RPLT0606	Historic Trams set (3) mint	TRAMS \$35.00
RPPT0607	Historic Trams collectors pack (2,500)	TRAMS \$40.00
RPLW0608	Spirit of Tasmania Crew Card (FV\$10) mint	SHIPPING \$12.00
RPLX0609	Map of Tasmania generic (FV\$5) mint	MAPS \$7.00
RPPX0610	Map of Tasmania generic collectors pack (2,500)	MAPS \$12.00
RPLT0611	West Coast Railway locomotives set (3) mint	TRAINS \$19.00
RPPT0612	West Coast Railway collectors pack (2,500)	TRAINS \$25.00
RPLT0613	Sunlander Railway locomotives set (2) mint	TRAINS \$15.00
RPPT0614	Sunlander Railway collectors pack (2,500)	TRAINS \$20.00
RPLL0615	Maatsuyker Lighthouse generic (FV\$5) mint	LIGHTHOUSE \$6.00
RPLP0616	Maatsuyker Lighthouse collectors pack (2,500)	LIGHTHOUSE \$10.00
RPLW0617	Sydney to Hobart Yacht Race 1994 set (4) mint	YACHTING \$40.00
RPPW0618	Sydney to Hobart Yacht Race 1994 collectors pack (2,500)	YACHTING \$47.50

PayTel Souvenir Cards - International Phonenumber and Banknote Fairs

RPLE0680	Sydney Banknote Fair March 1994 £10 Banknote	BANKNOTE \$12.00
RPLE0681	Sydney Phonenumber Fair March 1994 (Opera House)	OPERA HOUSE \$9.00
RPLE0682	Brisbane Phonenumber fair 1994 (city skyline)	LANDSCAPE \$6.00
RPLE0683	Melb Banknote and Phonenumber Fair 1994 pair (2) (city skyline)	LANDSCAPE \$12.00
RPLE0684	Sydney Banknote and Phonenumber Fair Nov 1994 pair (2) (city skyline)	LANDSCAPE \$12.00

PayTel Souvenir Cards - National Coin, Stamp and Phonenumber Fairs

RPLE0690	Darwin Stamp, Coin and Phonenumber (Kookaburra) Phonenumber	\$5.00
RPLE0691	Perth Stamp, Coin and Phonenumber (Yachting) Phonenumber	\$5.00
RPLE0692	Melbourne Stamp, Coin and Phonenumber (Koala)	\$5.00
RPLE0693	Sydney Stamp, Coin and Phonenumber (Opera House)	\$5.00
RPLE0694	Canberra Stamp, Coin and Phonenumber Koala	\$5.00
RPLE0695	Brisbane Stamp, Coin and Phonenumber (Gold Coast)	\$5.00
RPLE0696	Tasmania Stamp, Coin and Phonenumber (Shipping)	\$5.00

CARDPHONE AUSTRALIA

RCPS0750	Melbourne Cup Carnival 1994 collectors pack	HORSE RACING \$45.00
RCLS0751	Melbourne Cup Carnival 1994 loose cards (3 additional \$5, \$10, \$20)	HORSE RACING \$45.00
RCUS0752	Melbourne Cup Carnival 1994 full set (incl. pack, loose cards, \$3 generic and complimentary)	HORSE RACING \$95.00
RCLM0753	Baby's Day Out movie poster (FV\$5) mint	MOVIES \$15.00
RCLM0754	Miracle on 34th Street movie poster (FV\$5) mint	MOVIES \$15.00
RCLS0755	Australian Tennis Open 1994 Pat Cash (FV\$5) mint	TENNIS \$8.00
RCLS0756	Australian Tennis Open 1994 Wally Masur (FV\$5) mint	TENNIS \$8.00
RCLS0757	Australian Tennis Open 1994 complete set of 4 mint with matching serial (both \$5 and \$20 cards - \$20 show similar design to \$5 cards but only 250 of each printed) mint	TENNIS \$8.00
RCLS0758	Cricket Heroes - Alan Border (FV\$5)	CRICKET \$8.00
RCLS0759	Cricket Heroes - David Gower (FV\$5)	CRICKET \$8.00
RCLS0760	Cricket Heroes complete set of 4 mint (both \$5 and \$20 cards - \$20 show similar designs to \$5 cards but only 250 of each printed)	CRICKET \$75.00
RCLS0761	Streetfighter- Kylie Minogue Mint	MOVIES Available Soon

TELSTRA AUSTRALIA INTERNATIONAL ISSUES

(all have Australian prefix numbers)

Cambodia		
RILL0800	Laos Tower (FV US\$50) mint	LANDSCAPE \$240.00
RILL0801	Laos Tower (FV US\$50) used 1-hole	LANDSCAPE \$120.00
RILL0802	Laos Tower (FV US\$50) used multi-hole	LANDSCAPE \$60.00
RILL0803	Laos Temple (FV US\$100) mint	LANDSCAPE \$975.00
RILL0804	Laos Temple (FV US\$100) used 1-hole	LANDSCAPE \$675.00
RILL0805	Laos Temple (FV US\$100) used multi-hole	LANDSCAPE \$475.00
RILL0806	\$20 Green Temple prefix 185 used 1-hole	LANDSCAPE \$35.00
RILL0807	\$20 Green Temple prefix 185 used multi-hole	LANDSCAPE \$25.00
RILL0808	\$20 Green Temple prefix 258 used 1-hole	LANDSCAPE \$35.00
RILL0809	\$20 Green Temple prefix 258 used multi-hole	LANDSCAPE \$25.00
RILL0810	\$20 Green Temple prefix 519 mint	LANDSCAPE \$90.00
RILL0811	\$20 Green Temple prefix 519 used 1-hole	LANDSCAPE avail soon
RILL0812	\$20 Green Temple prefix 519 used multi-hole	LANDSCAPE avail soon
RILL0813	\$50 Green Temple prefix 185 used 1-hole	LANDSCAPE \$40.00
RILL0814	\$50 Green Temple prefix 185 used multi-hole	LANDSCAPE \$25.00
RILL0815	\$50 Green Temple prefix 252 used 1-hole	LANDSCAPE \$55.00
RILL0816	\$50 Green Temple prefix 252 used multi-hole	LANDSCAPE \$40.00
RILL0817	\$50 Green Temple prefix 253 used 1-hole	LANDSCAPE \$50.00
RILL0818	\$50 Green Temple prefix 253 used multi-hole	LANDSCAPE \$35.00
RILL0819	\$50 Green Temple prefix 258 mint	LANDSCAPE \$225.00
RILL0820	\$50 Green Temple prefix 259 mint	LANDSCAPE \$275.00
RILL0821	\$50 Green Temple prefix 305 mint	LANDSCAPE \$275.00
RILL0822	\$100 Green Temple prefix 191 mint	LANDSCAPE \$395.00
RILL0823	\$100 Green Temple prefix 191 used multi-hole	LANDSCAPE \$120.00
RIPL0824	Green Temple (3) collectors pack (only 400)	LANDSCAPE \$975.00
RILP0825	Third issue (\$2 Map of Earth and \$5 Satellite prefix 289 and 290) mint (2)	SPACE \$65.00
RILP0826	\$2 Map of Earth prefix 289 used 1 hole	MAPS/SPACE \$12.00
RILP0827	\$2 Map of Earth prefix 289 used multi-hole	MAPS/SPACE \$8.00
RILP0828	\$5 Satellite prefix 290 used 1-hole	SPACE \$40.00
RILP0829	\$5 Satellite prefix 290 used multi-hole	SPACE \$25.00
RILP0830	\$5 Satellite prefix 418 mint	SPACE \$60.00
RILP0831	\$5 Satellite prefix 418 used 1-hole	SPACE \$50.00
RILP0832	\$5 Satellite prefix 418 used multi-hole	SPACE \$35.00
RILL0833	Fourth Issue (\$2 Statue and \$5 Temple prefix 413 and 573) mint (2)	LANDSCAPE \$55.00
RILQ0834	\$2 Statue prefix 413 used 1-hole	ARTS avail soon
RILQ0835	\$2 Statue prefix 413 used multi-hole	ARTS avail soon
RILL0836	\$5 Temple prefix 573 used 1-hole	LANDSCAPE avail soon
RILL0837	\$5 Temple prefix 573 used multi-hole	LANDSCAPE avail soon
RIPL0838	MPTG collectors pack (only 2000) containing \$20 Green Temple prefix 519, third issue set and fourth issue set all mint	LANDSCAPE \$130.00

CHRISTMAS ISLAND

RILPO900	Trial Issue set (only 1980) \$10 Map of Earth and \$20 Satellite prefix 289 and 290 mint (2)	SPACE \$750.00
RILP0901	Trial Issue set used multi-hole	SPACE \$350.00
RILL0902	Pictorial issue \$10 Flying Fish Cove and \$20 Red Crab Migration prefix 384 and 385 mint (2)	LANDSCAPE/ANIMALS \$85.00
RILL0903	Pictorial issue 2nd print prefix 435 and 436 mint (2)	LANDSCAPE/ANIMALS \$65.00
RILL0904	Pictorial issue 2nd print prefix 435 and 436 used 1-hole (2)	LANDSCAPE/ANIMALS \$35.00
RILL0905	Third issue (no details as yet)	LANDSCAPE avail soon

NORFOLK ISLAND

RILW0925	First Issue Bounty Day (FV \$35) set (3) mint	SHIPPING/LANDSCAPE \$35.00
RILL0926	First Issue \$5 Kingston (capital city) prefix 554 mint	LANDSCAPE \$5.00
RILH0927	First Issue \$10 Bounty Day Parade prefix 555 mint	HISTORY \$10.00
RILW0928	First Issue \$20 The Bounty prefix 556 mint	SHIPPING \$20.00
RIPW0929	First Issue collectors pack (regular-6000)	SHIPPING/LANDSCAPE \$45.00
RIPW0930	First Issue collectors pack (European edition-2,500)	SHIPPING/LANDSCAPE \$45.00
RIPW0931	First Issue collectors pack (USA edition-2,500)	SHIPPING/LANDSCAPE \$45.00

RWANDA

RILP0975	Trial Issue set \$20 Map of Earth and \$50 Satellite prefix 418 and 520 mint (2)	SPACE \$295.00
RILP0976	Trial Issue set used 1-hole (2)	SPACE \$195.00
RILP0977	Trial Issue set used multi hole	SPACE \$90.00
RILP0978	Trial Issue \$20 Map of Earth prefix 418 mint	MAPS/SPACE \$120.00
RILP0979	Trial Issue \$20 Map of Earth prefix 418 used 1-hole	MAPS/SPACE \$50.00
RILP0980	Trial Issue \$20 Map of Earth prefix 418 used multi-hole	MAPS/SPACE \$35.00
RILP0981	Trial Issue \$50 Satellite prefix 520 mint	SPACE \$225.00
RILP0982	Trial Issue \$50 Satellite prefix 520 used 1-hole	SPACE \$170.00
RILP0983	Trial Issue \$50 Satellite prefix 520 used multi-hole	SPACE \$80.00

VIETNAM

RILP0999	\$50 Map of Earth prefix 289 issued for Vietnam Surf Carnival (very few) mint	MAPS/SPACE \$1450
----------	---	-------------------

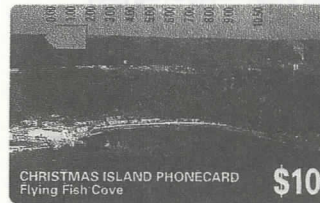

Christmas Island Pictorial issue (see RILP0902, 0903 and 0904)



Pay-Tel Trains I and II (see RPPT0611-14)



Pay-Tel Sydney to Hobart Yacht Race (see RPPW0618)

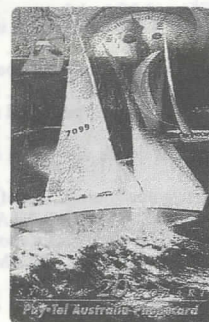
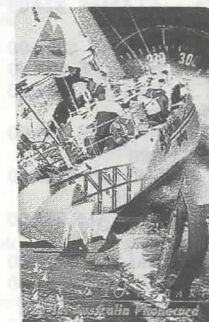

Status Retail

PO Box A2176, Sydney
 South, NSW 2000, Australia
 ☎ (02) 267 6116
 Fax (02) 267 6124
 Postage & Packing: Certified in Australia \$2 (loose cards only); \$4 (up to 5 folders); Overseas Registered Airmail: min A\$12 (loose cards); A\$15 (up to 3 folders); Ordinary Airmail (your risk) A\$2 (loose cards); A\$4 (up to 3 folders).
 Larger orders at our cost.

New Zealand

Advertising Cards (for list of NZ regular issues see our advertisement next month)

RNZP8500	Fernleaf Butter \$50 in mint collector pack	FOOD \$1750.00
RNZE8501	Telecom first AGM \$2 Satellite Dish mint	EXHIB \$65.00
RNZE8502	Auckland Fair \$5 Avondale Spider mint in folder	EXHIB/ANIMALS \$80.00
RNZP8503	Air Expo 1992 \$5 fighter plane in flight mint	PLANES \$15.00
RNZQ8504	13th Scout Jamboree \$5 scouts and rowboat mint	SCOUTS \$12.00
RNZP8505	Dominion Breweries \$5 company logo mint	ALCOHOL \$15.00
RNZS8506	Dominion Breweries \$5 "young guns" cricket team mint	SPORTS/ALCOHOL \$10.00
RNZA8507	Ansett Airlines \$5 Fluffy the Cat mascot mint	ANIMALS/AIRLINES \$35.00
RNZV8508	Mitre 10 Hardware stores \$5 people and parrot mint	BRANDS/ANIMALS \$15.00
RNZV8509	Financial Planning services \$5 logo	BRANDS \$15.00
RNZS8510	Auckland Round the Bays fun run \$5 mint	SPORTS \$10.00
RNZV8511	Ace Computers \$5 computer trainee	BRANDS \$10.00
RNZE8512	Christchurch phonecard fair \$5 Banks Peninsula	EXHIB \$10.00
RNZN8513	Chinese New Year \$50 Year of Rooster mint in folder	NEW YEAR \$900.00
RNZA8514	World Wildlife Fund \$5 collage of four animals mint	ANIMALS \$75.00
RNZE8515	Hong Kong Phonecard fair 1993 \$5 flower and NZ flag mint	EXHIB \$15.00
RNZR8516	Phantom of the Opera musical \$5 advert poster mint	MUSICALS \$40.00
RNZS8517	Shell Sports series 5 diff \$5 cards showing racing car, cricket, golf, racing boat and rugby mint (5)	SPORTS \$55.00
RNZQ8518	Rotary charity \$5 line of people mint	ROTARY \$15.00
RNZQ8519	Rotary charity \$5 "believe in what..." mint	ROTARY \$15.00
RNZP8520	Rotary charity \$5 Westpac rescue helicopter mint	PLANES/ROTARY \$15.00
RNZP8521	Rotary charity \$5 bush helicopter rescue mint	PLANES/ROTARY \$15.00
RNZE8522	Kiwi Collectors fair 1993 \$5 Kiwi native animal mint	ANIMALS \$18.00
RNZA8523	Critters Series \$50 Weta native animal mint	ANIMALS \$250.00
RNZA8524	Critters Series \$50 Katapo Spider mint	ANIMALS \$225.00
RNZA8525	Critters Series \$50 Stick Insect mint	ANIMALS \$225.00
RNZA8526	Critters Series \$50 Huhu Beetle mint	ANIMALS \$175.00
RNZE8527	Tuanz 1993 Exhibition \$5 logo	EXHIB \$10.00
RNZQ8528	Lions Club 1993 Red Nose Day set of 4 \$5 cards with baby photos mint	CHARITY \$35.00
RNZE8529	Telecom 2nd AGM \$5 satellite dish in folder mint	EXHIB \$110.00
RNZP8530	Ansett Airlines \$5 keys advert/passenger mint	AIRLINES \$10.00
RNZE8531	Telecom commitment to service \$5 sun in folder	TELECOM \$25.00
RNZV8532	Westpac handyline \$5 White Island mint	BANKING \$15.00
RNZM8533	Jurassic Park set 4 diff \$5 cards showing scenes from movie mint in folder	MOVIES \$45.00
RNZE8534	Philatelia Fair in Cologne \$5 elephant seals mint	ANIMALS/EXHIB \$10.00
RNZR8535	Music Legends \$5 Elvis (from the heart) mint	MUSIC \$25.00
RNZR8536	Music Legends \$5 Elvis (collectors gold) mint	MUSIC \$25.00
RNZR8537	Music Legends \$20 Elvis Presley mint	MUSIC \$55.00
RNZM8538	Music Legends \$20 Marilyn Monroe mint	MOVIES \$55.00
RNZR8539	Music Legends \$20 Madonna mint	MOVIES/MUSIC \$55.00
RNZR8540	Music Legends \$20 Whitney Houston mint	MOVIES/MUSIC \$55.00
RNZN8541	Christmas 1993 \$5 Spot the Dog (red) mint	CHRISTMAS/ANIMALS \$45.00
RNZN8542	Christmas 1993 \$5 Spot the Dog (blue) mint	CHRISTMAS/ANIMALS \$45.00
RNZL8543	South Pacific Hotels set 10 \$5 cards showing hotels mint	HOTELS \$90.00
RNZQ8544	Scouting Regatta 1993 \$5 scouts in sail boat mint	SCOUTS \$10.00
RNZV8545	Build your business \$5 logo mint	BUSINESS \$9.00
RNZV8546	Westpac Project Crimson \$5 tree mint	BANKING/TREES \$12.00
RNZC8547	Motorfest \$5 collage of classic cars mint in folder	CARS \$25.00
RNZQ8548	Wellington Arts Festival \$5 logo mint	ARTS \$9.00
RNZS8549	Rugby Sevens pair of \$5 cards players in action mint	RUGBY \$20.00
RNZP8550	Ansett Airlines \$5 flytrap/passenger	AIRLINES \$10.00
RNZP8551	Warbirds over Wanaka pair of \$5 cards classic WW2 fighters	PLANES \$45.00
RNZE8552	Singapore Phonecard fair \$5 Spot the Dog/ Raffles Hotel mint	EXHIB/ANIMALS \$22.00
RNZR8553	Blood Brothers \$5 advert poster for musical mint	MUSICAL \$10.00
RNZB8554	Christchurch fair/ Britten Superbike mint	MOTORCYCLES \$32.00
RNZG8555	Otumoetai College \$5 Maori girl mint	SCHOOL/WOMEN \$12.00
RNZV8556	Roche Aurorix \$5 depression drug mint	MEDICAL \$10.00
RNZN8557	Chinese New Year \$50 Year of the Dog mint in folder	NEW YEAR \$395.00
RNZV8558	Benson & Hedges Fashion Awards \$5 models mint	BRANDS \$12.00
RNZP8559	Air New Zealand set of 4 (2x\$5, 2x\$10) aircraft mint	PLANES \$49.00
RNZD8560	Lion King \$5 movie advert in folder with CD soundtrack (only 4000) mint	DISNEY/MOVIES \$70.00
RNZP8561	Japan Airlines \$5 logo (bird - crane) mint	AIRLINES/ANIMALS \$12.00
RNZE8562	Cardex 94 (Amsterdam) fair \$5 Spot the Dog	EXHIB/ANIMALS \$12.00
RNZS8563	Steinlager Rugby \$5 players in action mint	RUGBY \$10.00
RNZQ8564	Blind Foundation 2 \$5 cards in folder with guidedogs (cards are also lottery tickets)	CHARITY/ANIMALS \$30.00
RNZS8565	Ranfurly Shield 8 \$5 cards players in action mint	RUGBY \$65.00
RNZA8566	Amcal chemists \$5 emperor penguin mint	ANIMALS/MEDICAL \$12.00
RNZC8567	Auckland fair \$5 vintage cars in folder with two specimen cards (only 3500) mint	CARS \$35.00
RNZA8568	Society for Prevention of Cruelty \$5 animals mint	ANIMALS \$10.00
RNZA8569	Albatross \$5 bird (only 3500) mint in folder	ANIMALS \$30.00
RNZL8570	Trenz \$20 tourist advert mint in folder	LANDSCAPE \$40.00
RNZS8571	Healthy School set 4 \$5 cards incl Volleyball	SPORT \$30.00
RNZE8572	Tuanz 1994 Exhibition \$5 logo mint in folder	EXHIBITION \$15.00
RNZV8573	Auckland Airport Duty Free \$5 Advert	BRANDS \$10.00
RNZN8574	Happy Mother Days \$5 flowers Mint in folder	HOLIDAY \$10.00
RNZN8575	To Mother \$5 flowers mint in folder Holiday	HOLIDAY \$10.00
RNZN8576	Happy Fathers Day \$5 sailing ship in folder	HOLIDAY \$10.00
RNZN8577	Happy Birthday \$5 party mint in folder	HOLIDAY \$10.00
RNZR8578	Music Legends set of 5 \$2 cards featuring Aretha Franklin, Ray Charles, Louis Armstrong, Billie Holiday and B.B King Mint (5)	MUSIC \$195.00
RNZQ8579	Lions Club 1994 Red Nose Day set of 2 \$5 cards mint in folders	CHARITY \$20.00
RNZQ8580	Anne Geddes set of 4 \$5 cards baby photos mint	ART \$35.00
RNZN8581	Missing you \$5 lonely dog mint in folder	HOLIDAY \$10.00

RNZA8582	Kiwi \$5 Winner 1983 Melbourne Cup Mint	HORSE RACING \$9.00
RNZL8583	Water Care \$5 rivers and lakes mint	LANDSCAPE \$9.00
RNZX8584	Farmers two \$5 cards NZ Flag and Family at home	BRANDS/FLAGS \$16.00
RNZF8585	Guidelines for Drivers \$5 blood alcohol limits	MEDICAL/ALCOHOL \$9.00
RNZS8586	Road Safety Association \$5 BMW car	CARS \$10.00
RNZJ8587	Casino \$50 playing card mint in folder	GAMBLING \$70.00
RNZD8588	Christmas 1994 three cards Christmas decorations mint in folders	CHRISTMAS \$35.00
RNZW8589	Shooter Jet \$5 jet boat	SHIPPING \$9.00
RNZD8590	Snow White set of three \$5 cards mint	DISNEY \$35.00
RNZD8591	Snow White in collectors folder (only 4000) including three mint cards	DISNEY \$85.00

News from around the World...

Oceania

RSIQ8017	Solomon Islands 2nd issue set (\$10, 2 x \$20, \$50) Native Culture used (4)	\$25.00
RSIQ8018	Solomon Islands 2nd set \$50 high value used	\$10.00
RTOL8019	Tonga 1st issue set (3) mint in pack Island Scenes (less than 1000 issued)	\$90.00
RTOL8020	Tonga 1st issue \$5 Island Scene mint	\$10.00

Coca-Cola



Germany mint \$25



Hungary pair mint (2) \$25



Marilyn Monroe

USA - New Marilyn cards (see ad elsewhere in this issue)...	
RUSM1029 Marilyn Monroe Christmas/New Year Greetings - Gem International (set of 4, FV US\$45) mint	\$75

Status Retail

PO Box A2176, Sydney South,
NSW 2000, Australia

☎ (02) 267 6116 Fax (02) 267 6124

Postage & Packing: Certified in Australia \$2 (loose cards only); \$4 (up to 5 folders); Overseas Registered Airmail: min A\$12 (loose cards); A\$15 (up to 3 folders); Ordinary Airmail (your risk) A\$2 (loose cards); A\$4 (up to 3 folders).

Larger orders at our cost.

For a listing of Worldwide cards in stock, including themes such as Coca-Cola, please see pages 30-32 of last month's **Phonecard Collector** magazine or send \$2 in stamps to receive a copy.

Lunar New Year phonocard series from Singapore

SINGAPORE TELECOM has joined with the Singapore Mint to issue a presentation folder containing four Lunar New Year telephone cards and a commemorative medallion for the Year of the Pig.

Characteristics of those born in the Year of the Pig

THEY are usually quick minded, easy going, determined, peace loving, sensitive and upright. But sometimes, deep down, they can be materialistic, authoritative and indecisive.

They only talk when necessary and dislike arguing. On the whole, they make the best of friends. Due to their conscientiousness and diligence, they will excel in any field and occupation.

However, they must refrain from any undesirable hobbies or habits, for they easily indulge in one. And, if they do, it will be very difficult to get a Pig out of all of these.

Those born in the Year of the Rabbit will be the most suitable lifelong companion for Pigs. They must be watchful of those born in the year of the Snake and Goat.

The four \$5 telephone cards depict traditional Chinese Lunar New Year images and together, form a composite picture. The cards show Sweet Cake, Gold Coins, Mandarin Oranges and Gold Ingots.

Pig Medallion 1995

THE obverse design of the medallion features the painting, "The Sun Setting and Green Grass: by the late Liu Kuiling (1885-1967). Liu was a renowned animal, flower and bird painter of Tianjin origin. He was widely known and loved for the unique artistic style employed on his paintings.

The reverse design features Chinese characters which translate as "to bring wealth for your family".

 Status Retail, Shop 533, Royal Arcade, 255 Pitt Street, Sydney, NSW 2000, Australia. ☎ (02) 267 6116, Fax (02) 267 6124.

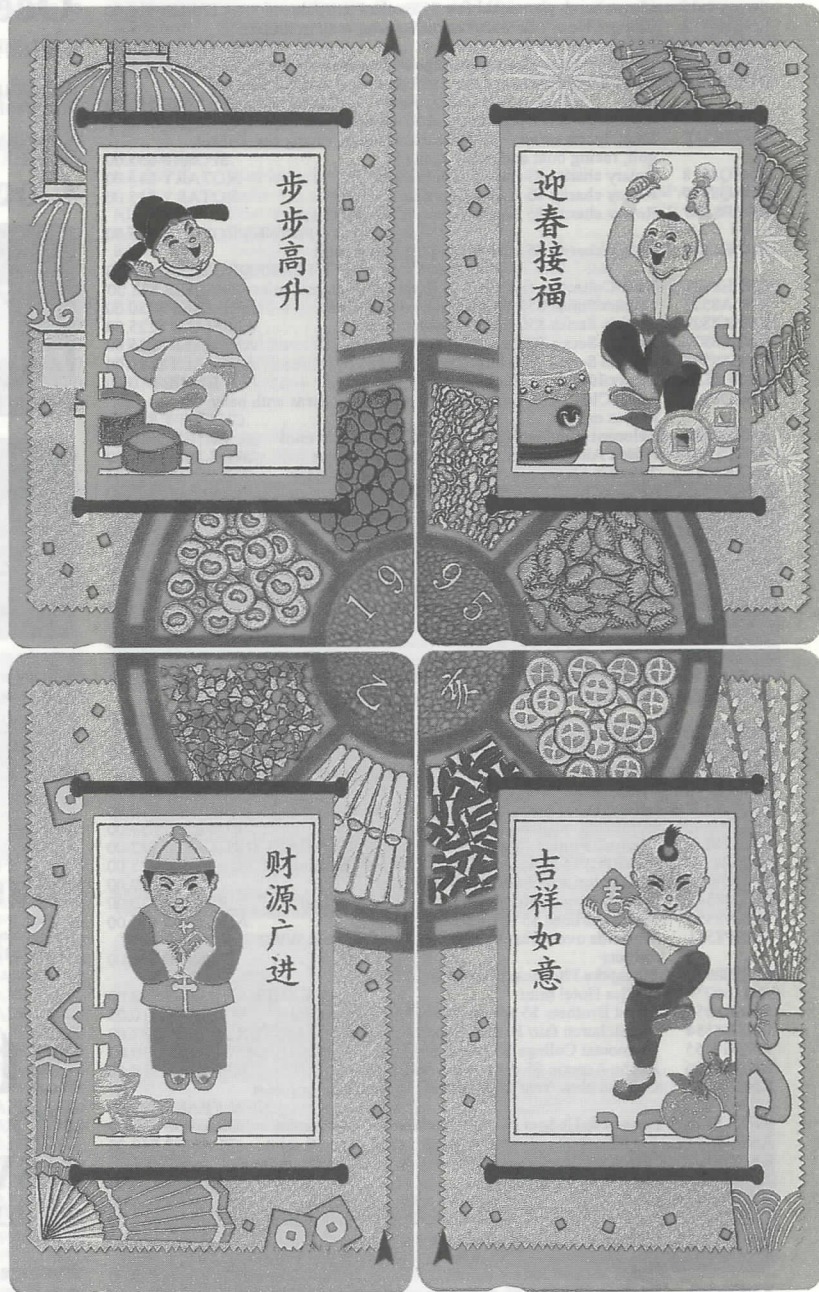

Phonocard Collector

Customer Service
Contact Information:

Editorial: Gordon Thomas, GPO Box 3780, Sydney, NSW 2001, Australia. ☎ (02) 264 7060

Advertising: Brian Moore, GPO Box 3780, Sydney, NSW 2001, Australia. ☎ (02) 264 7060

Bulk Supplies: Gordon Thomas, GPO Box 3780, Sydney, NSW 2001, Australia. ☎ (02) 264 7060

Subscription, Accounts: GPO Box 3780, Sydney, NSW 2001, Australia. ☎ (02) 267 4525; Fax: (02) 267 6124

Special purchase of VST telephone card album pages

Due to a substantial purchase from the manufacturer, we are able to offer quantities of the popular VST telephone card album page (with 8 pockets) at substantial savings off recommended retail price (\$1.10).

10 pages (80 pockets)	(99½ cents each) \$9.95
50 pages (400 pockets)	(90 cents each) \$45.00
100 pages (800 pockets)	(80 cents each) \$80.00
250 pages (2000 pockets)	(70 cents each) \$175.00
500 pages (4000 pockets)	(65 cents each) \$325.00
1000 pages (8000 pockets)	(60 cents each) \$600.00

Delivery in Australia (be sure to give a physical address, NOT a P O Box for delivery; \$4 extra on orders under \$50; \$10 on orders under \$100; \$20 on orders under \$500; \$30 on orders over \$500. (Despatch within 24 hours.) Overseas: Contact us for a quotation.

Payment: Cheque, Money Order or Credit Card (Bankcard, MasterCard, Visa authority) with order.

Phonecard Collector

GPO Box 3780, Sydney, NSW 2001, Australia.

☎ (02) 264 7060

AL'S PHONECARDS

Shop 29, Pacific Power Building, 37 Park Street, Sydney, NSW 2000, Australia

☎ (02) 267 5931 Fax (02) 267 1279

DESCRIPTION	SINGLE HOLE	SINGLE HOLE SET	MULTI HOLE	MULTI HOLE SET	DESCRIPTION	SINGLE HOLE	SINGLE HOLE SET	MULTI HOLE	MULTI HOLE SET
\$2 Health & Safety \$10}			\$5}		\$5 Kakadu \$3}			\$2}	
\$2 Blood Transfusion \$20}			\$14}		\$10 Lizard \$3}	\$19		\$2}	\$12
\$5 Community Services \$12}			\$6}	\$39	\$20 Flinders Island \$15}			\$10}	
\$5 Red Cross Youth \$12}	\$69		\$6}		\$5 Microscopic \$2}	\$16		\$1}	\$10
\$10 Disaster Relief \$12}			\$6}		\$10 Microscopic \$4}			\$2}	
\$20 Assignments \$12}			\$6}		\$20 Microscopic \$12}			\$8}	
\$2 Hockey \$20}			\$15}		\$5 Christmas 1993 \$3}	\$5		\$2}	\$3
\$5 Willie Koala \$25}			\$15}		\$10 Christmas 1993 \$4}			\$2}	
\$5 Swimming \$3}	\$62		\$2}	\$39	\$5 New Logo \$2}	\$10 & \$5		\$1}	\$22
\$5 Cycling \$3}			\$2}		\$10 New Logo \$4}			\$2}	
\$10 Track & Field \$3}			\$2}		\$20 New Logo \$7}			\$4}	
\$20 Marathon \$14}			\$10}		\$5 Recycle \$4}	\$18		\$3}	\$10
\$5 Snag \$3}			\$2}		\$10 Plant a Tree \$4}			\$3}	
\$5 Answering Machine \$3}	\$19		\$2}	\$10	\$20 Green Consumer \$12}			\$6}	
\$10 Volume \$3}			\$2}		\$5 Dinosaur \$2}	\$16		\$1}	\$10
\$20 Bats \$12}			\$8}		\$10 Dinosaur \$4}			\$2}	
\$5 Christmas '92 \$2}	\$5		\$1}	\$3	\$20 Dinosaur \$12}			\$8}	
\$10 Christmas '92 \$4}			\$2}		\$5 Bilby \$2}	\$16		\$1}	\$10
\$2 Generic \$2}			\$1}		\$10 Turtle \$3}			\$2}	
\$5 Generic \$10}	\$55		\$5}	\$33	\$20 Finch \$12}			\$8}	
\$10 Generic \$8}			\$4}		\$5 Dancer \$3}	\$17		\$2}	\$12
\$20 Generic \$16}			\$10}		\$5 Ballet \$3}			\$3}	
\$50 Generic \$26}			\$20}		\$10 Dancer \$4}			\$7}	
\$5 Old Logo \$2}			\$1}		\$20 Ballet \$10}	\$10		\$2}	\$6
\$10 Old Logo \$4}	\$35		\$2}	\$22	\$5 Cyclist \$3}			\$2}	
\$20 Old Logo \$7}			\$4}		\$5 Swimmer \$3}	\$22		\$2}	\$13
\$50 Old Logo \$25}			\$18}		\$10 Shot-Put \$6}			\$4}	
\$5 Wallaby \$5}	\$15		\$3}	\$9	\$5 Boy Under Water \$3}	\$13		\$2}	\$6
\$5 Wombat \$5}			\$3}		\$5 Lifesavers \$3}			\$2}	
\$10 Numbat \$8}			\$5}		\$10 Lifesaving \$5}			\$3}	
\$5 Indigenous \$4}	\$19		\$3}	\$15	\$5 Christmas 1994 \$2}			\$1}	
\$10 Indigenous \$4}			\$3}		\$10 Christmas 1994 \$4}			\$2}	
\$20 Indigenous \$15}			\$10}		\$20 Christmas 1994 \$9}			\$4}	

We also sell Mint Cards and Collector's Packs

Market Report 7

GEELONG (pack \$240)



\$1.50 Go Together
mint \$85
1 hole \$85
used \$70



\$3 Float and Wave
mint \$15
1 hole \$12
used \$8



\$6 Reach to Rescue
mint \$15
1 hole \$12
used \$8



\$1.50 Surf Boats
mint \$40
1 hole \$40
used \$35



\$3 Zodiac
mint \$15
1 hole \$15
used \$10



\$6 Surf Crew
mint \$70
1 hole \$65
used \$60

SOUTH AUSTRALIA (pack \$500)



\$2 Vineyard
mint \$35
1 hole \$20
used \$6



\$2 River Murray
mint \$45
1 hole \$40
used \$20



\$5 Adelaide Grand Prix
mint \$45
1 hole \$15
used \$10



\$5 Flinders Ranges
mint \$45
1 hole \$20
used \$15



\$10 Kangaroo Island
mint \$75
1 hole \$60
used \$35



\$20 Adelaide City
mint \$180
1 hole \$30
used \$15

GENERIC 1990 (\$5 pack \$120)



\$2 Logo
mint \$5
1 hole \$3
used \$1



\$5 Logo
mint \$45
1 hole \$15
used \$6



\$10 Logo
mint \$195
1 hole \$12
used \$3



\$20 Logo
mint \$75
1 hole \$25
used \$6



\$50 Logo
mint \$70
1 hole \$45
used \$20

500th GRAND PRIX (pack \$80)



\$5 Alfa and Wreath
mint \$60
1 hole \$30
used \$15

QUEENSLAND (pack \$280)



\$5 Barrier Reef
mint \$20
1 hole \$15
used \$10



\$5 Gold Coast
mint \$20
1 hole \$20
used \$20



\$10 Brisbane City
mint \$195
1 hole \$100
used \$65

VICTORIA (pack \$400)



\$5 Melbourne City
mint \$20
1 hole \$10
used \$4



\$5 River Murray
mint \$25
1 hole \$12
used \$4



\$10 Grampians
mint \$60
1 hole \$15
used \$6

NEW SOUTH WALES (pack \$650)



\$2 Orang-utan
mint \$15
1 hole \$3
used \$2



\$2 Echidna
mint \$20
1 hole \$4
used \$3



\$5 Platypus
mint \$30
1 hole \$28
used \$25



\$5 Giraffe
mint \$50
1 hole \$25
used \$15



\$10 Cheetah
mint \$250
1 hole \$15
used \$8



\$20 Zoo Entrance
mint \$60
1 hole \$45
used \$20

ACT (pack \$300)



\$2 Royal Aust. Mint
mint \$20
1 hole \$18
used \$10



\$2 Canberra View
mint \$40
1 hole \$35
used \$20



\$5 Questacon
mint \$15
1 hole \$15
used \$10



\$5 War Memorial
mint \$40
1 hole \$35
used \$20



\$10 Telecom Tower
mint \$150
1 hole \$60
used \$30

WEST AUSTRALIA (pack \$80)



\$2 Perth Skyline
mint \$25
1 hole \$25
used \$20



\$5 Karri Forest
mint \$25
1 hole \$25
used \$20



\$10 Bungle Bungles
mint \$30
1 hole \$30
used \$25

NORTHERN TERRITORY (pack \$65)

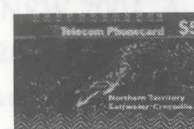

\$5 Crocodile
mint \$25
1 hole \$25
used \$20

Subscribe to Phonecard Collector, save money and get your magazine sooner!

Keep up-to-date with the market... subscribe to Phonecard Collector today!

Keep up-to-date with new issues... subscribe to Phonecard Collector today!

	\$5 Ayers Rock	
	mint	\$45
	1 hole	\$45
	used	\$40

TASMANIA (pack \$65)

	\$2 Cradle Mountain	
	mint	\$40
	1 hole	\$40
	used	\$30

	\$5 Hunter Street	
	mint	\$25
	1 hole	\$25
	used	\$20

GENEVA CONFERENCE (pack/folder \$700)

	\$5 Koala	
	mint	\$190
	1 hole	\$150
	used	\$140

RED CROSS (pack \$320)

	\$2 Health and Safety	
	mint	\$15
	1 hole	\$15
	used	\$4

	\$2 Blood Transfusion	
	mint	\$35
	1 hole	\$25
	used	\$15

	\$5 Community Service	
	mint	\$30
	1 hole	\$15
	used	\$3

	\$5 Youth	
	mint	\$30
	1 hole	\$15
	used	\$3

	\$10 Disaster Relief	
	mint	\$60
	1 hole	\$8
	used	\$3

	\$20 Assignments	
	mint	\$60
	1 hole	\$20
	used	\$10

AUSTRALIA DAY 1992 (pack \$90)

	\$5 Abstract	
	mint	\$45
	1 hole	\$35
	used	\$20

OLYMPIC GAMES 1992 (pack \$350)

	\$2 Hockey	
	mint	\$65
	1 hole	\$25
	used	\$8

	\$5 Willy	
	mint	\$50
	1 hole	\$15
	used	\$8

	\$5 Swimming	
	mint	\$30
	1 hole	\$3
	used	\$1

When you have phonecards to sell... bear in mind that a dealer, out of commercial necessity, will offer you less than his selling price. He has to *make a living* out of trading.

	\$5 Cycling	
	mint	\$30
	1 hole	\$3
	used	\$1

	\$10 Track & Field	
	mint	\$30
	1 hole	\$3
	used	\$1

	\$20 Marathon	
	mint	\$45
	1 hole	\$15
	used	\$8

TELECOM ADVERTISING

	\$5 Messages	
	mint	\$12
	1 hole	\$2
	used	\$1

	\$5 Hit a Snag	
	mint	\$15
	1 hole	\$3
	used	\$2

	\$10 Turn up the Volume	
	mint	\$25
	1 hole	\$2
	used	\$1

	\$20 Don't Hang Around	
	mint	\$40
	1 hole	\$15
	used	\$8

CHRISTMAS 1992

	\$1.50 Bird Choir	
	mint	\$200
	1 hole	\$200
	used	\$175

(Note: \$1.50 issued in greeting card folder.)

	\$5 Wombats on Beach	
	mint	\$15
	1 hole	\$3
	used	\$2

	\$10 Koala Santa Claus	
	mint	\$60
	1 hole	\$5
	used	\$3

AUSTRALIA DAY 1993 (pack \$45)

	\$5 Happy Faces	
	mint	\$20
	1 hole	\$3
	used	\$2

TELECOM GENERIC - TOURISM

	\$5 Sydney Opera House	
	mint	\$10
	1 hole	\$2
	used	\$1

	\$10 Kangaroo	
	mint	\$20
	1 hole	\$3
	used	\$1

	\$20 Great Barrier Reef	
	mint	\$30
	1 hole	\$5
	used	\$2

	\$50 Koala	
	mint	\$120
	1 hole	\$75
	used	\$40

Phonecard Collector Classified ... It really works

ENDANGERED SPECIES (pack \$120)

	\$5 Wallaby	
	mint	\$25
	1 hole	\$3
	used	\$2

	\$5 Wombat	
	mint	\$25
	1 hole	\$3
	used	\$2

	\$10 Numbat	
	mint	\$20
	1 hole	\$4
	used	\$3

Market Report prices are based on a compilation of leading dealer's prices.

INDIGENOUS PEOPLE - Aboriginal Art (pack \$45)

	\$5 Creation of Life	
	mint	\$7
	1 hole	\$4
	used	\$3

	\$10 Life on Earth	
	mint	\$15
	1 hole	\$5
	used	\$3

	\$20 Eternity	
	mint	\$25
	1 hole	\$15
	used	\$10

ADVERTISING CARDS 1993

	\$5 KMart / AC Cola	
	mint	\$8
	1 hole	\$8
	used	\$6

	\$10 KMart / Camping	
	mint	\$14
	1 hole	\$12
	used	\$8

	\$20 KMart / Clothing	
	mint	\$25
	1 hole	\$20
	used	\$12

	\$10 XXXX - Beer	
	mint	\$14
	1 hole	\$12
	used	\$8

LANDSCAPE 1993 (pack \$45)

	\$5 Kakadu Billabong	
	mint	\$7
	1 hole	\$2
	used	\$1

	\$10 Lizard Island	
	mint	\$12
	1 hole	\$5
	used	\$3

	\$20 Northern Flinders Ranges	
	mint	\$25
	1 hole	\$15
	used	\$6

When you have phonecards to sell... bear in mind that top prices are asked (and offered) only for top quality cards. Inferior copies, with bends or scratches are worth less.

SYDNEY OLYMPIC BID 2000

	\$5 Olympic Bid Logo	
	mint	\$25
	1 hole	\$15
	used	\$8

MICROSCOPY - Micro-photographs (pack \$70)

	\$5 Marine Plankton	
	mint	\$7
	1 hole	\$2
	used	\$1

	\$10 Butterfly Eggs	
	mint	\$12
	1 hole	\$5
	used	\$3

	\$20 Pollen Grains	
	mint	\$25
	1 hole	\$15
	used	\$8

TELECOM GENERIC (New Logo)

	\$5 Sydney Opera House	
	mint	\$8
	1 hole	\$2
	used	\$1

	\$10 Kangaroo	
	mint	\$25
	1 hole	\$12
	used	\$1

	\$20 Great Barrier Reef	
	mint	\$30
	1 hole	\$6
	used	\$2

	\$50 Koala	
	mint	\$80
	1 hole	\$40
	used	\$25

ENVIRONMENT PROTECTION (pack \$60)

	\$5 Recycle	
	mint	\$7
	1 hole	\$3
	used	\$2

	\$10 Plant a Tree	
	mint	\$12
	1 hole	\$5
	used	\$3

	\$20 Be a Green Consumer	
	mint	\$25
	1 hole	\$6
	used	\$3

CHRISTMAS 1993

	\$5 Outback Consumer	
	mint	\$10
	1 hole	\$3
	used	\$2

	\$10 City Christmas	
	mint	\$20
	1 hole	\$5
	used	\$3

AUSTRALIA DAY 1994 (pack \$100)

	\$5 Abstract Design	
	mint	\$15
	1 hole	\$3
	used	\$2

AUSTRALIAN DINOSAURS (pack \$120)

	\$5 Muttaborrasaurus	
	mint	\$7
	1 hole	\$2
	used	\$1

	\$10 Austrosaurus	
	mint	\$12
	1 hole	\$4
	used	\$2

	\$20 Minmi	
	mint	\$25
	1 hole	\$15
	used	\$7

TAMWORTH COUNTRY MUSIC FESTIVAL [PACS] (pack \$70)

	\$5 Golden Guitar Award	
	mint	\$35
	1 hole	\$35
	used	\$30

	\$5 Lee Kernaghan	
	mint	\$35
	1 hole	\$35
	used	\$30

YEAR OF THE DOG

	\$5 Dog on Ball	
	mint	\$8
	1 hole	\$8
	used	\$5

	\$5 Dog on Unicycle	
	mint	\$8
	1 hole	\$8
	used	\$5

	\$5 Dogs and Flowers	
	mint	\$8
	1 hole	\$8
	used	\$5

	\$5 Dog and Ribbon	
	mint	\$8
	1 hole	\$8
	used	\$5

SWISS [PACS] (pack \$45)

	\$5 Chocolate Bar	
	mint	\$35
	1 hole	\$35
	used	\$30

ENDANGERED SPECIES/WWF (pack \$90)

	\$5 Bilby	
	mint	\$7
	1 hole	\$2
	used	\$1

	\$10 Western Swamp Turtle	
	mint	\$12
	1 hole	\$3
	used	\$2

	\$20 Gouldian Finch	
	mint	\$25
	1 hole	\$15
	used	\$8

LANDSCAPE 1994 (pack \$75)

	\$5 Bollard's Lagoon, SA	
	mint	\$8
	1 hole	\$7
	used	\$4

Phonocard Collector Classified ... It really works!
 Advertise your wants - or your spare cards -
 for only 50 cents per word (maximum)!

	\$5 Lamington Nat. Park	
	mint	\$8
	1 hole	\$7
	used	\$4

	\$5 E. Alligator River	
	mint	\$8
	1 hole	\$7
	used	\$4

	\$5 The Pinnacles	
	mint	\$8
	1 hole	\$5
	used	\$4

	\$5 Mt. Ben Lomond	
	mint	\$8
	1 hole	\$5
	used	\$4

	\$10 Mt. Hotham	
	mint	\$12
	1 hole	\$2
	used	\$1

	\$20 Crescent Head	
	mint	\$25
	1 hole	\$8
	used	\$4

DANCE/BALLET

	\$5 Ballet	
	mint	\$7
	1 hole	\$2
	used	\$1

	\$5 Dance	
	mint	\$7
	1 hole	\$2
	used	\$1

	\$10 Dance	
	mint	\$12
	1 hole	\$3
	used	\$1

	\$20 Ballet	
	mint	\$25
	1 hole	\$8
	used	\$4

COMMONWEALTH GAMES (pack \$70)

	\$5 Diving	
	mint	\$7
	1 hole	\$2
	used	\$1

	\$5 Cycling	
	mint	\$7
	1 hole	\$2
	used	\$1

	\$10 Shot Put	
	mint	\$12
	1 hole	\$3
	used	\$2

PHONECARD COLLECTOR MAGAZINE

	\$2 Phonocard Collector magazine	
	mint	\$40
	1 hole	\$40
	used	\$35

TOYOTA

	\$2 New Corolla	
	mint	\$40
	1 hole	\$40
	used	\$35

Got something to say? Then write to the editor.

Phonocard Collector February 1995

AUSTRALIAN WILDLIFE FUND

-  \$5 Koala pack \$25
-  \$10 Duck pack \$50



ETTAMOGAH PUB (pack \$50)

-  \$5 Ettamogah Pub mint \$40
1 hole \$40
used \$38

STEAM LOCO 1210

-  \$5 Train folder \$25



AUSTRALIAN FOOTBALL LEAGUE

-  \$2 Gary Ablett pack \$25
-  \$2 Tony Modra pack \$25



ALBURY HIGH SCHOOL (pack \$30)

-  \$2 School mint \$15
1 hole \$15
used \$12



OPERA HOUSE (pack \$70)

-  \$5 Opera House Festivities mint \$22
-  \$5 Opera House by Day mint \$22
-  \$5 Olympic Night mint \$22

MUSEUM OF CONTEMPORARY ART (pack \$75)

-  \$2 Circular Quay, Sydney mint \$12
-  \$20 Campbell's Soup Can mint \$65

AUSTRALIAN FOOTBALL LEAGUE



-  \$2 Stephen Silvagni pack \$20
-  \$2 Chris Mainwarring pack \$20

Encourage a child to become a phonecard collector. The young are the hobby's future!

APOLLO 11 - 25 YEARS (pack \$300)

-  \$2 Saturn V Lift-off mint \$15
1 hole \$2
used \$1
-  \$5 Lunar Module *Eagle* mint \$20
-  \$10 Descending the ladder mint \$20
-  \$20 Astronauts deploy the flag mint \$60
-  \$50 Tranquility Base mint \$225



COURAGE UNDER FIRE (pack \$40)

-  \$5 Fire Fighter mint \$15
-  \$5 The Aftermath mint \$15

VICTORIA STAMP TRADERS - 30th ANNIVERSARY

-  \$2 Globe mint \$10



SPIES HECKER (pack \$60)

-  \$5 Alfa Romeo mint \$22
-  \$5 Osca mint \$22
-  \$5 Ferrari mint \$22

AUSTRALASIAN STAMP DEALERS' ASSOCIATION (ASDA) STAMP CLASSICS #1 (pack \$25)

-  \$5 Western Australia 4d "inverted swan" mint \$25

RALLY AUSTRALIA (pack \$60)

-  \$5 Subaru mint \$20
-  \$5 Mobil mint \$20

Phonecard Collector Classified ... It really works!
Advertise your wants - or your spare cards - for only 50 cents per word (maximum)!

- \$5 Winners mint \$20

ZOOS (pack \$35)

-  \$5 Elephants, etc mint \$13
-  \$5 Orang-utan, etc mint \$13

CARDEX '94 (pack \$65)

-  \$5 Australian flowers mint \$10
1 hole \$8
used \$6





BOOKMUNCHER

-  \$5 Bookmuncher mint \$7
1 hole \$2
used \$1

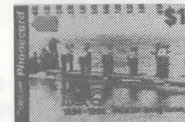

SOCIAL SECURITY

-  \$4 Payphone booth mint \$10
1 hole \$2
used \$1

SURF LIFE SAVING (pack \$50)

-  \$5 Underwater mint \$7
1 hole \$2
used \$1
-  \$5 Rescue mint \$7
1 hole \$2
used \$1
-  \$10 Life Saving History mint \$12
1 hole \$2
used \$1
-  \$20 Boat Rescue mint \$25
1 hole \$15
used \$10

CHRISTMAS (pack \$45)



-  \$5 Christmas mint \$7
1 hole \$2
used \$1
-  \$10 Christmas mint \$12
1 hole \$2
used \$1
-  \$20 Christmas mint \$25
1 hole \$5
used \$3

Explanation of Terms



mint - a mint card is one in perfect, unused condition, without folds or blemishes
1-hole - a used card, with only 1-hole punched and otherwise in fine used condition
used - a used card with two or more holes punched, otherwise in good condition

Pay-Tel Australia

ABEL TASMAN TRIALS (pack \$225)

	\$5 Devonport
	\$10 Launceston
	\$20 Hobart
mint set (3) \$175	

SPIRIT OF TASMANIA (pack \$70)

	\$5 ferry
	\$10 ferry
	\$20 ferry
mint set (3) \$65	



TT LINE CREW CARD

	\$10 Crew card
mint \$12	



GENERIC - MAP (pack \$12)

	\$5 'Olde Worlde' Map
mint \$7	

WILDERNESS RIVERS (pack \$50)



	\$5 river
	\$10 river
	\$20 river
mint set (3) \$45	

TRAMS (pack \$40)

	\$5
mint \$5	
	\$10
mint \$10	
	\$20
mint \$20	
mint set (3) \$35	

Phonecard Collector Classified ... It really works!
 Advertise your wants - or your spare cards -
 for only 50 cents per word (maximum)!

TRAINS (pack \$25)

	\$3 "S" Class Diesel
mint \$3	
	\$6 "R" Class "Hudson"
mint \$6	
	\$10 "Titania"
mint \$10	
mint set (3) \$19	

A Unique of Phonecard History!

Your opportunity to have in your collection a true collecting "first".

For a limited time and strictly on a first come, first served basis, I can offer you the first Historic Post Offices phonecard pack featuring the Fingal (Tasmania) Post Office, signed personally by the licensee and handstamped with the office date and name stamp.

A limit of two packs per customer applies and, as only a small number have been signed and stamped, your speedy reply will ensure you won't miss out.

Send a cheque or money order for A\$30 for each pack required. Please allow 2 weeks for delivery if paying by personal cheque.

Send today!

**J.M. Welling, 1 Talgitcha Street,
 Wedderburn, Vic 3518, Australia.**

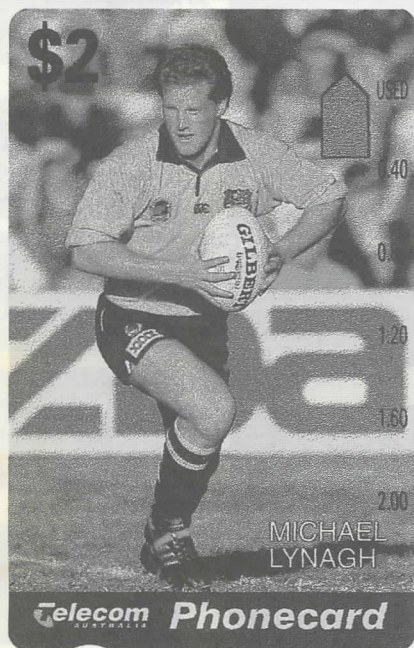

Captains of Rugby Phonecard Series

Laser Sport Pty Ltd has contracted Status Retail to distribute its series of sporting cards to collectors and dealers. The first Laser Sport card issue comprises a \$2 Telecom Australia card showing Wallabies Captain, Michael Lynagh and a \$5 Telecom New Zealand card showing All Black Captain, Sean Fitzpatrick.

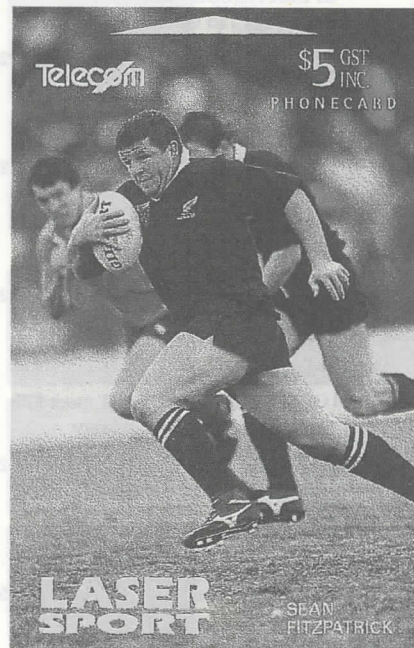

An exciting dimension is added to the issue by the fact that both cards will be united in a single Collector's Pack - the first joint-issue pack containing both an Australian and a New Zealand phonecard issued on the same subject.

Michael Lynagh card in Collector's Pack - A\$19.50

Joint issue - Michael Lynagh AND Sean Fitzpatrick cards in Collector's Pack - A\$39.50

Postage & Packing: Certified in Australia (up to 5 folders) A\$4; Overseas Registered Airmail (up to 3 folders) A\$15; Ordinary Airmail - *your risk* - (up to 3 folders) A\$4.

Status Retail, PO Box A2176, Sydney South, NSW 2000, Australia

(02) 267 6116 Fax (02) 267 6124 American Express, Bankcard, Diners' Club, MasterCard, Visa welcome

PLAYBOY



FIRST PHONECARD SERIES

You can now order your set of the first Playboy limited edition USA phonecard series: "Playmates on the Move." Mintage is strictly limited to 4,999 sets. The issuing price is US\$98. (The illustrations above are close ups of the girls. Their pictures on the cards are far more revealing.) At the same time, you can order the holiday edition, consisting of three cards in a Christmas folder featuring Playmate of the Year, Jenny McCarthy and Santa Claus. Mintage is again only 4,999 sets. You can obtain the sets from your local phonecard dealer or directly from the distributor:

U.S. Telegard Service, PO Box 3722, Gottingen 37073, Germany.
 ☎ / Fax +49 551 378475

Sets "Playmates on the Move"
 @ A\$149

"Playboy Holiday Series"
 @ A\$79

Other items:

Postage A\$9.00

TOTAL

Name:

Street:

City:

Country:

Zip/Code:

☎ Number:

Please choose your preferred method of payment (please tick): VISA MASTERCARD

Card Number:

Expiry Date:

Signature:

Cheque enclosed

Send to: U.S. Telegard Service,
 PO Box 3722, Gottingen 37073, Germany.
 ☎ / Fax +49 551 378475

USA PHONECARDS FROM OUR SALES LIST

Coca-Cola Polar Bear Chipcard (Germany) A\$29

U.S. South Chipcards Civil War set (5000) A\$59

Sprint Coca-Cola set with folder. The King of all Coke sets. Mintage only 2000. A\$149

Coke + Coke Light set (Hungary) A\$35

Sprint - Telegard World Card - Saturn from Voyager A\$19

PTC Marilyn Monroe set (1500) A\$19

Amerivox
 Lady Washington A\$29
 Rails to Tidewater A\$29
 De Zeven Provincien . A\$29

PTC Disney set (only 1500 sets) A\$159

Sprint
 Disney - Goofy A\$29

Lion King
 (2 card set) Germany A\$39

G.T.I.
 Flinstones set (5 cards) A\$89

Brilliant Universe
 San Francisco Puzzle (5000)
 4 cards with folder A\$59

Walt Disney's Merry Mouse

Brilliant Universe San Francisco Puzzle (5000) 4 cards with folder A\$59

Call now for complete saleslist. Collectors in the US are growing in numbers now. Start your collection of the good USA phonecards now before prices rush out of sight. Investment portfolios available. All prices in A\$. VISA and MASTERCARD accepted. U.S. Telegard Service, PO Box 3722, Gottingen 37073, Germany. ☎ / Fax +49 551 378475

Fundamentals

To begin with

by Danny Jurd

THE big question confronting a new phonecard collector is *what to collect?* Do you collect mint, used or whatever?

Over the past few years, one of the most popular styles of collecting for enthusiasts both here and in New Zealand has been the collection of Collector Packs.

Certainly as far as investment goes, this style of collecting has shown itself to be the most active area of the hobby.

Over the past year most of the Australian collector packs have increased in value in a big way.

Now prices are a little less stable and in a lot of cases have fallen, but they are still a solid collecting area and most prices are still well over double their levels of a year ago.

What is a collector pack?

A collector pack (also known as a collector edition) is a group or set of

phonecards that is offered in a nicely presented folder containing details on the cards and the scenes that they feature.

Australia's first collector edition was released when the Geelong trials were issued in 1989.

Initially, the cards that were issued in the packs and the cards that were released for general sale were basically the same, in terms of prefix and so on.

However in the past year, Telecom has released packs that include cards that are only available in collector edition folders.

While the face of the cards may appear the same as the released product, the backs of the cards may have a different inscription such as "Limited Collector Edition".

Thus, the only way to get such a card is to buy the collector edition. Illustrated on this page, it is easy to see how the backs of the cards differ.

This collecting style is a convenient and easy way to collect Australian Phonecards.

For people wishing to collect Australia's limited edition collector packs as they are released, a standing order can be placed directly with Telecom.

When it comes to older issues, most dealers, such as those advertising in this magazine stock a full range of collector packs.

However, not all Australian phonecards are released in collector edition packs.

Examples of this include the Generic issues - those

■ This card is for Coin / Card Payphones in Australia ■ It contains \$5.00 worth of calls ■ Don't bend or stain and avoid magnetic fields ■ A punched hole shows approximate remaining call value ■ For local, STD and International calls: N940842

\$5

Telecom AUSTRALIA

© Telstra Corporation Limited 1993 Non Refundable



9 316423 000208

Autocall number
(use felt tip pen)

Phonecard



0044928820

11 holes ■ For local, STD and International calls: C945111

Telecom AUSTRALIA

© Telstra Corporation Limited 1993 Non Refundable
TM - Trademark Telstra Corporation Limited

Phonecard™

LASERSPORT
PHONECARD No. 1



0066009010

Above: A National issue Telecom phonecard (the \$5 Landscape card showing The Pinnacles, WA); Below: A Custom Card (the \$2 Lasersport Michael Lynagh card). Note the differences between the card types obvious on the back.

boring looking cards that featured a stylised telephone handset.

Only the \$5 from this series was put into a pack.

There are other examples as well, mostly advertising cards and the like.

Collectors wanting these will need to buy them loose.

There are other cards available in packs, but not from Telecom. These are the Custom Cards.

Custom cards

REGULAR readers of *Phonecard Collector* will have seen last month's column by Torsten Weller, in which he described the systems and philosophy behind Custom Cards.

Custom Cards are, as the name suggests, cards that are produced to order on behalf of either an individual or organisation.

These are produced for a variety of purposes, sometimes as a promotion for a company for their product, or primarily with the collector in mind.

Those that are produced with the collector in mind are available from phonecard dealers.

Unlike Telecom's general release cards, custom cards are not generally available at face value. *Why?* you may ask.

To recap, custom cards have to be purchased from Telecom at face value (plus a premium for production) by the issuing party. They are usually packaged at further expense and in many cases, royalties are paid to the owners of the copyright on the images used. The result is a product which must be sold above face.

The first custom cards were produced last year for the Tamworth country music festival.

Since Tamworth, a good range of Custom cards has been produced, many of which are advertised in this magazine.



The National version of the 1994 \$20 Christmas card, coded N943134a. Note the bar code at left.

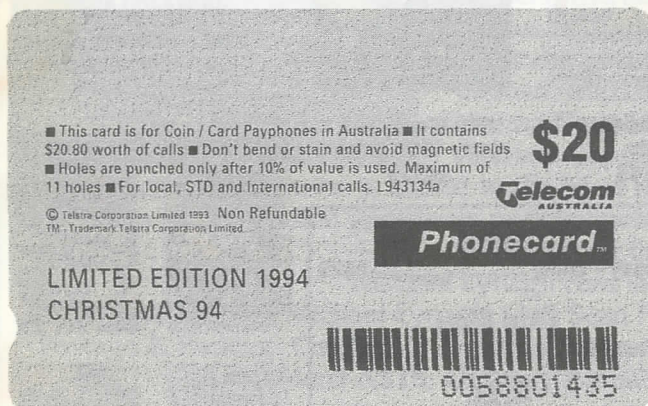

The Limited Edition version of the 1994 \$20 Christmas card, coded L943134a. Note the inscription "LIMITED EDITION 1994/CHRISTMAS 94" and the absence of bar code at left.

Images have ranged from *Mickey Mouse* to the first manned moon-landing. These cards are not only face different to Telecom's own general issue cards, but they have different features on the reverse as the illustrations below show..

So generally speaking you will not usually find Custom cards for sale at your newsagent and Telecom definitely does not handle sales of these cards.

However, in recent months, there have been instances where custom cards have been sold through local newsagencies.

These are just two of the ways that one can build up a worthwhile collection of phonecards.

All this column attempts is to give collectors some broad ideas to build upon, and maybe some basis guidelines to follow.

A difficult choice?

ONE of the reasons phonecard collecting is growing so fast as a hobby is the way it attracts young people. However, speaking as a "not so old person" myself, I remember well the problems associated with being young and having a hobby.

My number one problem was always money. As the old saying goes, I didn't have any money worries because I didn't have any money to worry about!

So I am quite sympathetic when I see younger collectors coming into the shop I work at, looking at the more expensive cards and wishing they could afford them.

What's a young collector do? Saving is always a good idea, however, in the short term there *is* a solution.

Last month, I suggested readers consider the virtue of collecting *fine* examples of used phonecards - whilst steering clear of scratched or otherwise damaged cards.

If I was a young collector and I couldn't afford to pay \$30 for a multi-hole \$50 Generic, but I had \$5 or so, what should I do?

One school of thought suggests the exercise of patience, waiting for a good example at a more affordable price.

But, younger collectors often prefer to keep filling gaps to keep their interest bubbling.

So, in this case, buying a "second" as a temporary spacefiller may not be such a bad thing.

Most dealers will have a seconds board around their shop. There, you will find cards that are priced according to their condition

This may just be a way to fill those gaps. But, be warned: Examine the card closely before you buy it, whilst being realistic enough to accept that, in view of its lower price, it may be far from perfect.

Gremlins

GREMLINS found their way into last month's column in which we illustrated two examples of the \$10 South Australia.

Captions for good and poor copies were transposed, as I am sure most readers would have realised!

Next month: prefixes

ONE of the questions most-asked by new collectors of Australian Phonecards is, "What is a prefix or batch number?"

Next month we will look at what these numbers are and why people collect them.

Your questions answered...

WE don't pretend to know *all* the answers here at *Phonecard Collector*, but we do know some of them.

We invite readers to send in their questions and queries about collecting, printing and technical matters to be dealt with in this column. We cannot answer questions individually, however. Write to: "Fundamentals", GPO Box 3780, Sydney, NSW 2001, Australia.

Gabriele's Phonecard Service

A Division of Gabriele's Philatelic Service Pty Ltd

Suite C2, Mirvac Building, 160 Castlereagh Street, Sydney, NSW 2000
PO Box A2, Sydney South, NSW 2000, Australia ☎ / Fax (02) 283 1311

**SEND FOR OUR FREE COLOURED
CATALOGUE / PRICE LIST
PHONE, FAX OR WRITE TODAY**



**FREE Complimentary "Tiger" phonecard available.
See our catalogue for details on how to get yours!**

**To: Gabriele's Philatelic Service Pty Ltd
PO Box A2, Sydney South, NSW 2000, Australia**

Please forward to me a copy of your **Free**
Phonecard Catalogue/Price List.

Name:

Address:

Postcode:

News from overseas...

The latest hot thematic cards have arrived. Just a few are illustrated here - join our mailing list to receive continual updates.



Stargate (5000)
(new movie sensation)
US, mint ... \$25



Robocop (2000)
US, mint ... \$45



Aliens (Japan) mint \$20
(lots of other titles available)

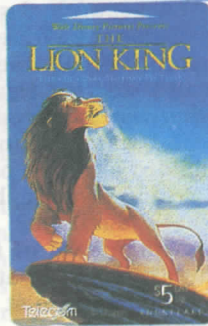

Lion King (NZ) in limited CD pack (4000)
mint \$75

Germany (1500)
Coca-Cola set (3) in folder,
mint \$225



England Thunderbirds
in folder (1500)..... \$25



Australia Coca-Cola - first issue - now available
Two different cards, each in a different pack.
Price per pack \$25



King Kong (Nynex, USA)
mint set of 3
(incl. complimentary) \$35



Allan Leavell Houston Rockets
(400 only) all signed ...\$35

Coca-Cola Belgium
(1000 only) mint \$139



Coca-Cola McDonalds UK
mint \$25

Coca-Cola Germany
mint, in folder \$25



Coca-Cola/Mello Yello USA mint (1500) \$90



Coca-Cola Denmark
mint \$60

Coca-Cola Czech
used \$30



Coca-Cola Shanghai (China)
mint \$45

Coca-Cola BT (1500 only)
mint \$95



POSTAGE & PACKING

Certified in Australia \$2 (loose cards only); \$4 (up to 5 folders);
Overseas Registered Airmail: min. A\$12 (loose cards); A\$15 (up to 3 folders); Ordinary Airmail (your risk) A\$2 (loose cards); A\$4 (up to 3 folders).

Status Retail

PO Box A2176, Sydney South, NSW 2000, Australia

(02) 267 6116 Fax (02) 267 6124

American Express, Bankcard, Diners' Club, MasterCard, Visa

Currency Collector

(ISSN 1323-174X) is published monthly in Stamp Collector and Phonocard Collector magazines at Suite 1403 (14th Floor), 255 Pitt Street, Sydney, NSW 2000, AUSTRALIA

(Visitors strictly by appointment only.)

Publisher & Editor-in-Chief: Brian Moore Marketing Director: Barry Jarrett

Editorial and Advertising enquiries to Brian Moore Ph (02) 264 7060 Fax (02) 264 7138

All correspondence to: **Currency Collector**, GPO Box 3780, Sydney, NSW 2001, Australia

Perth Mint news

ALL the Perth Mint's 1994 proof coin issues and other special issues for the year were sold out after being heavily oversubscribed.

The proof issues were of Australian Kangaroo Nuggets, Australian Koalas, Australian Kookaburras and three-metal sets.

One special issue was a series of four Kangaroo silver coins with privy marks on gold inserts of the effigies of the four British monarchs shown on gold sovereign coins produced at the Mint between 1899 and 1931.

Each of the coins in the series was released in conjunction with a coin fair conducted by the Numismatic Association of Australia (NAA).

The other special issue was a 15,000 coin issue for the Australian team for the Commonwealth Games held in Victoria, British Columbia, Canada last August. This issue helped raise funds for the team's expenses.

Goldcorp privatisation

THE Board of Gold Corporation made recommendations to the Western Australian Government last December about the Corporation's future.

Last May, the WA Government,

which is the Corporation's sole shareholder, invited expressions of interest in acquiring a minority interest in the organisation.

There were 13 expressions of interest received by the June 30 deadline and the Corporation subsequently held detailed discussions with three parties who, it was felt were best qualified to enhance the Corporation's activities in the long term.

The report to the Government outlined all the options for the Corporation's future and made recommendations about them.

It is expected that the WA Cabinet will make a decision early in 1995.

The WA Government is not fully committed to the sale of a minority or any interest, but has been keen to review future options in the light of developments in the international precious metal industry.

If it decides to sell an interest, legislation would be required which would probably prolong the until the middle of 1995.

The WA Government has said that the driving factor behind the examination of its options was its desire to build on the success that had been achieved with the Corporation.

The issue that would weigh heavily in its decision-making was how an association between the Corporation and other organisation might "add value" to both operations.

Criteria identified as being of par-

ticular importance were:

- * increasing the expertise and level of activity in precious metals treasury and related foreign exchange dealings;

- * the potential for rationalising gold and refining in Australia and the nearby region; and

- * securing distribution channels for Gold Corporation's range of value added precious metals products.

The Government formed Gold Corporation in 1988 and based it on the historic Perth Mint which has been refining gold and manufacturing coinage since 1899.

Goldcorp in Indonesia

WESTERN AUSTRALIA'S Gold Corporation has established a presence in Indonesia with the appointment of Marshall Cooper as its Commercial Manager for the country, effective last November 1.

Mr Cooper was formerly Commercial Services Manager for PT Kelian Equatorial Mining in Indonesia

He is operating from Jakarta with the aim of developing a wide range of services for the Indonesian mining and precious metals industries.

Indonesia gold production has grown rapidly in recent years, raising from 18 tonnes in 1991 to 46 tonnes in 1993.

Further increases will occur over the next few years. With a high economic growth rate and 180 million people, the country is also a potentially important market for precious metal products.

AUSTRALIAN & WORLD BANKNOTES

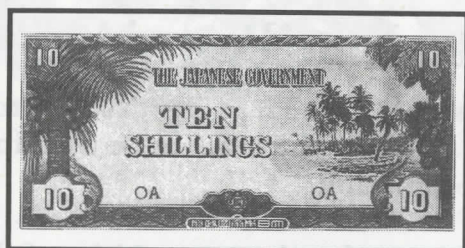

- * Free catalogues
- * Personal Service
- * Competitive prices
- * Accurate grading
- * 20 years' experience
- * Confidentiality guaranteed

Return the attached
FREE CATALOGUE COUPON
for your copy by return mail.

JOHN PETTIT
G.P.O. Box 4593,
Sydney, NSW 2001,
Australia

(02) 489 2207 Fax (02) 489 4299

FREE CATALOGUE COUPON

To: John Pettit
G.P.O. Box 4593,
Sydney, NSW 2001,
AUSTRALIA

Please send me your latest free
catalogue by return mail:

I am a: beginner
 advanced collector

Name:

Address:

Postal Bid Sale

Coins, banknotes:
We offer regular sales of 5,000+ lots, including:

World Coins - Most Countries (3,000 lots) in all metals including Gold; Australia - Commonwealth Series, Gold, Banknotes, Decimal, Tokens, Medallions & shares. World Banknotes, Ancients - Roman Coins, Great Britain, U.S.A., Bulk Lots & Dealers/Resellers' Lots.

A wide range of lots to suit almost any collecting interest and budget - Lots from \$2 to \$1,000. Please request our Free Catalogue.

Why Australia's new polymer currency is the safest in the world

WHILE Australia's counterfeit-ing problem is small by international standards, it is becoming more serious, given the availability of sophisticated print technology.

Almost five times more counterfeit paper notes were passed or seized in 1993 than in 1992. To date, no counterfeits of \$5 and \$10 polymer notes have surfaced.

Like the polymer \$5 and \$10 notes which preceded it, the new \$20 note issued on October 31 last year has many anti-counterfeiting devices in its design - the most prominent being a printed image of a compass. It is only with Australia's polymer technology that security devices like the window can be incorporated into notes.

Apart from better security, polymer notes provide other important benefits: they last much longer than paper notes and stay cleaner; and they can be recycled into various products, whereas paper notes cannot be recycled.

Reserve Bank of Australia to incorporate new security devices into currency notes.

Another first is that, within the window, the denomination numerals have been embossed into the clear polymer substrate and they become visible as the note is tilted.

Also, within the window, an image of a compass has been printed which can be seen from either side of the

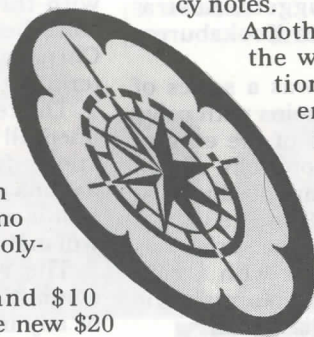

note.

Other security devices incorporated in the \$20 note include: raised print, which can be felt, is used for the portraits and other major design elements; microprinting incorporated in the design on either side of the note; intricate multi-coloured, fine line pattern; when the note is held up to the light, a seven pointed star within a circle is formed; and the Australian Coat of Arms is visible underneath other printing, similar to a watermark on paper notes.

What makes the note more secure?

PUT simply, polymer enables the

i If readers suspect they have a note which might be counterfeit, they should make contact with the local police or the Reserve Bank on ☎ 008 633 220.



P.O. Box 1616, Ballarat Mail Centre, Vic 3354, AUSTRALIA
Phone (053) 33 2202, Fax (053) 33 3153
Paul Bickerton, Deirdre Parker

Yes, I'd like to receive your latest Catalogue.

Name:

Address:

Country:

Mail this coupon to:

Coin Trends, P.O. Box 1616, Ballarat Mail Centre, Vic 3354, Australia

Wanted to Buy 1945 Australian Pennies

We have been commissioned by a large organisation to obtain a quantity of 1945 pennies which are to be used for a promotion.

We are consequently seeking to buy large quantities of this single coin (1945 pennies only) and are offering \$1 each CIF, delivered to our premises at 234 Flinders Street, Melbourne, Vic 3001.

Please ship whatever quantity you have available for immediate delivery.

Max Stern & Co, Melbourne

I.S. WRIGHT

more than just a coin dealer

For more than two decades, I.S. Wright has been a market leader in Australian numismatics, with branches in **Adelaide, Ballarat, Melbourne** and two in **Sydney**. We also have a **travelling representative** who is able to visit clients in those more remote areas.

Our Ballarat office conducts postal bid sales in two categories - Numismatic and Militaria. Sales occur six times yearly and each contains up to 10,000 lots.

Our four retail shops have a range of stock more diverse than any other dealer. From Ancient Greek to this year's latest issue and everything in between.

Not only will you benefit from such a diverse selection of stock, there is the added bonus of talking to some of Australia's most knowledgeable numismatists. Our combined experience is second to none.

Whether you are a beginner, a seasoned collector or an investor: **you can talk to us.**

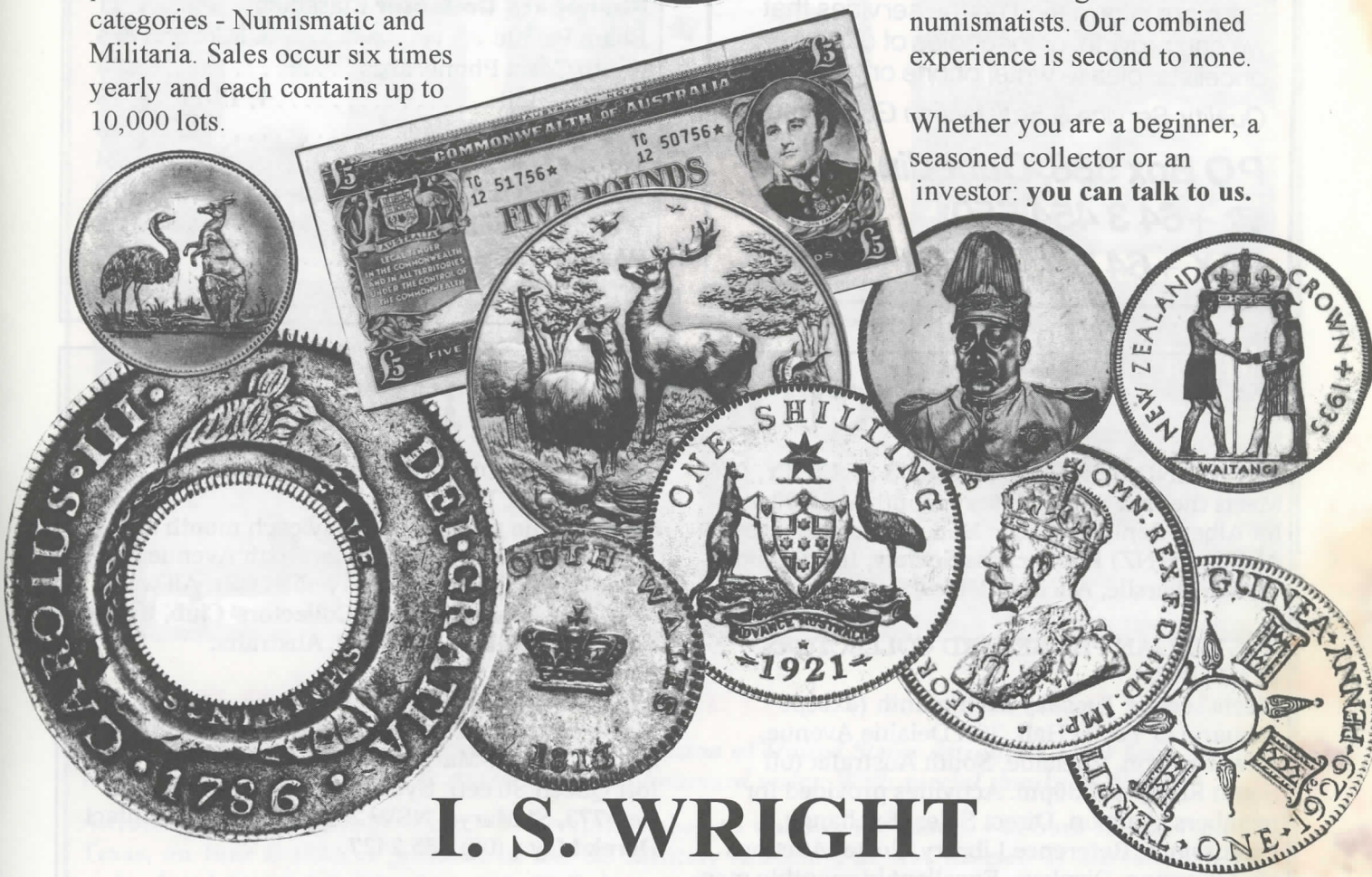

I. S. WRIGHT

Australian and world coins, gold and silver, war medals, medallions, banknotes, militaria; in fact almost anything collectable.

more than just a coin dealer

Adelaide
Shop 33
Adelaide Arcade
Adelaide SA 5000
Ph (08) 223 7603
Fax (08) 223 2129
Manager - Grant Morton

Ballarat
208 Sturt Street
Ballarat Vic 3350
Ph (053) 32 3856
Fax (053) 31 6426
Numismatic - Stewart Wright
Militaria - Paul O'Brien
Travelling Rep - Laurie Nugent

Melbourne
289 Flinders Lane
Melbourne Vic 3000
Ph (03) 650 2345
Fax (03) 650 2345
Manager - Bill Baker

Sydney
Royal Arcade
255 Pitt Street (under Hilton)
Sydney NSW 2000
Ph (02) 267 3062
Fax (02) 267 7971
Managers - Barry Sparks
John Nielsen

Sydney
Shop W15, Wynyard Station
George Street
Sydney NSW 2000
Ph (02) 299 8870
Fax (02) 299 8964
Manager - David Allen

A M Kilpatrick Phonocard Specialist

We specialise in supplying top quality mint and used cards from New Zealand, Australia, the Pacific and North America. We also have an extensive range of foreign cards, both mint and used, so we can attend to your country or thematic interests. If the card that you require is not in stock, then we will try to obtain it for you. We also offer a superior standing order service for all the cards of New Zealand. Standard issues are supplied at face value, collectors packs at Telecom price and Ad cards at best. Pacific and North America can also be supplied on standing order. For more information on the services that we can provide, or for copies of our pricelists, please write, phone or fax today.
Quality, Service & Satisfaction Guaranteed

PO Box 588, Dunedin, NZ.

+64 3 454 5501

FAX +64 3 454 5501

Directory of Advertisers

Al's Phonocards	19
The Christie Collection	8
Coin Trends	30
Gabriele's Phonocard Service	27
Harbour City Stamps & Phonocards	12
International Numismatics	5
Kilpatrick, A M	32
Massone, Antonio	10
Max Stern & Co, Melbourne	30
M.E.F. Books	6, 10
Mini-Display Ads	10
Pay-Tel Australia	3
Pettit, John	29
Phonocard Collector Classified	11
Roam Pacific	Cover 3 & 4
South Coast Phonocards	4
Status Retail	7, 13-17, 24, 28
U.S. Telecard Service	25
Welling, J.M.	24
Westbury Trading Co Limited	10
Worldwide Collectables	Cover 2
Worldwide Telecard	10
Wright, I.S.	31

Directory of Clubs

AUCKLAND (NZ) PHONOCARDS SOCIETY, INC
Meets the first Sunday every month at 10.30am, Mt Albert Senior Citizens Hall. Postal enquiries to: Auckland (NZ) Phonocards Society, Inc, PO Box 11456, Ellerslie, Auckland, New Zealand.

AUSTRALIAN PHONOCARD COLLECTORS CLUB, INC

Meets second Tuesday each month (except January) at Toc-H Hall, 30A Delaine Avenue, Edwardstown, Adelaide, South Australia (off South Road) at 7.30pm. Activities provided for members: Auction, Direct Sales, Exchange, Discussions, Reference Library, Postal Auctions via Magazine, Displays. Excellent bi-monthly magazine. Contact Secretary, Glenis Hymers, 64 Concord Drive, Reynella, SA 5161, Australia ((08) 381 3449.

THE MELBOURNE PHONOCARD CLUB, INC

Meets first Saturday each month at 1pm at the Northcote Senior Citizens Centre, 18A Bent Street, Northcote (Melway 30 E7). Visitors welcome. The club seeks exchange of Australian for international phonocards. The Melbourne Phonocard Club, Inc, PO Box 197, Heidelberg West, Vic 3081, Australia.

ROSEBUD & DISTRICT PHONOCARD COLLECTORS' CLUB, INC

Meets on the second Saturday each month at the Anglican Church Hall, Corner Sixth Avenue and Point Nepean Road (Melway 158 D12). All welcome! Rosebud & District Collectors' Club, Inc, PO Box 211, Rosebud, Vic 3939, Australia.

SYDNEY PHONOCARD CLUB

Meets on the fourth Wednesday each month at the Auditorium, St Marys Bowling Club, Carson Lane (off Queen Street). Sydney Phonocard Club, PO Box 773, St Marys, NSW 2760, Australia. Contact Derek May ((02) 835 2427.

THE PHONOCARD CLUB OF TASMANIA, INC

Meets monthly at the Goodwill Community Centre. Members receive a quarterly newsletter featuring a Postal Auction and the latest news. There is a "Swap Shop" and a "High Flyers" listing. This is supplemented by a monthly flyer. For meeting and membership details, contact: Sam Bailey, Secretary, The Phonocard Club of Tasmania, Inc, PO Box 816, Rosney, Tas 7018, Australia.

FREE LISTING in this directory for bona-fide phonocard clubs in the Asia-Pacific region.

Roam Pacific presents:

Apollo 15 Moonlanding

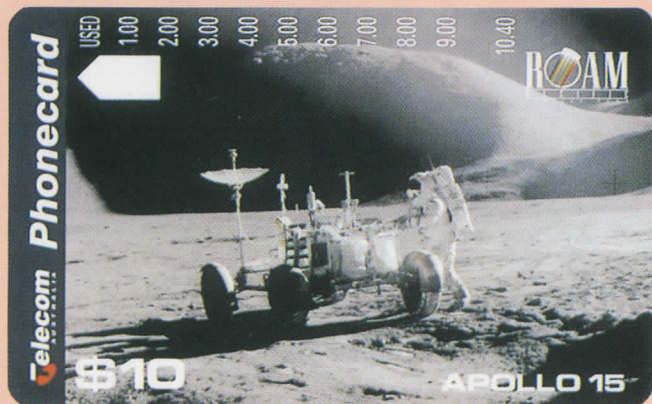
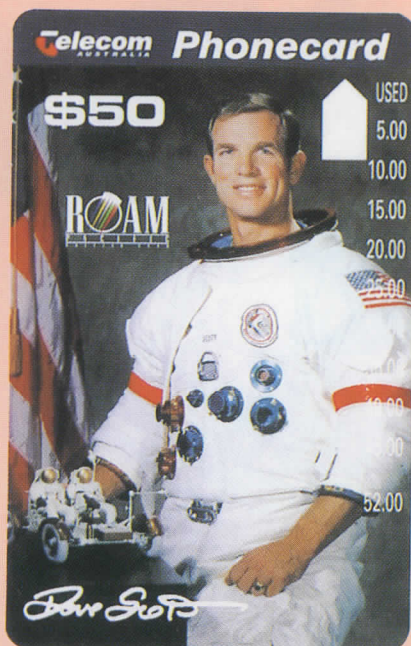
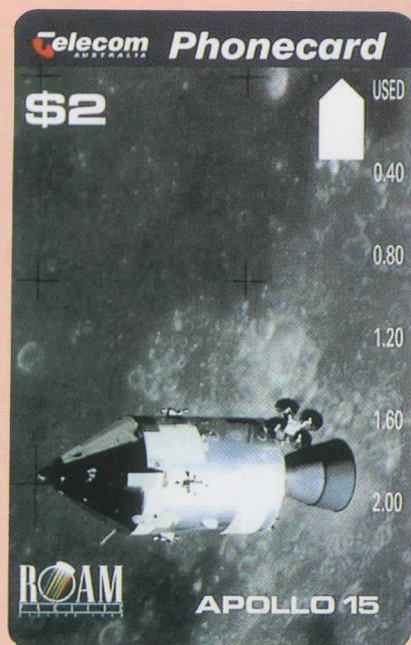

Astronaut Dave Scott - the first licensed lunar driver!

Roam Pacific gratefully acknowledges the participation of United States Astronaut, Dave Scott, in this, the second of Roam's Telecom Australia space phonocard series. With special thanks to NASA.

Astronaut, David Randolph Scott, the seventh human to walk on the moon, was born in San Antonio, Texas, on June 6 1932. A graduate of the US Military Academy, he was selected as astronaut in 1963 and piloted Gemini 8 (together with Neil Armstrong) and Apollo 9, the earth orbit test of the full Apollo spacecraft. As commander of the Apollo 15 mission, launched on July 26 1971, he landed the spacecraft on the moon's surface on August 7 1971 - the fourth manned moonlanding. Dave Scott and his pilot *roamed* the lunar surface for 6½ hours, using the first ever lunar rover.

The Apollo 15 series is unique in that it is only the second collector pack of Australian phonocards ever produced containing the full range of Telecom Australia denominations (\$2, \$5, \$10, \$20 and \$50). The first was Roam's Apollo 11 series. As of January 1995, due to a change in Telecom policy, all \$2 phonocards will bear the words "Complimentary Only", making this issue a rarity.

Limited to 3000 sets



See order form over page

Australian War Memorial



AWAS anti-aircraft station



Assault on Buna



Australian War Memorial

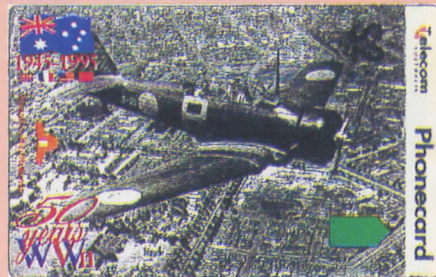

Australian Wirraway aircraft



Assault on Salamaua

World War II Commemoration Phonecards

Roam Australia, in association with the Australian War Memorial, is issuing the five Telecom Australia phonecards above in commemoration of the 50th anniversary of the end of World War II.

Limited Edition

Due: Early February 1995

Also available directly from the Australian War Memorial, Canberra, your local dealer, and

Roam Australia Pty Limited ACN 065 475 498

☎ (02) 221 8896 (Roam Pacific) Fax (02) 221 5010

Mailing Address: Roam Australia, PO Box Box A1009, Sydney South, NSW 2000 - Fax (02) 221 5010

ORDER FORM

Please specify your exact requirement below)

Order Number	Qty	Description	Unit Price in AUSS	Total Price in AUSS
AP15-50		Apollo 15 Full 5-card collectors pack	\$215.00	
AP15-20		\$20 LM Falcon	\$ 40.00	
AP15-10		\$10 Lunar Rover	\$ 20.00	
AP15-05		\$5 Splashdown	\$ 15.00	
AP15-02		\$2 CCM Edeavour FREE with purchase of each AP15-05+AP15-10+AP15-20 (combination)		
WWII-01		WWII 5-Card collectors pack	\$ 75.00	
		Local post & packing where applicable AUS \$3.50	\$ 3.50	
		Overseas post & packing where applicable AUS \$15.00	\$ 15.00	
		Insurance where applicable		
			TOTAL(AUSS)	

*Please note all transactions in Australian Dollars (AUSS). *Orders will be processed in order of receipt

Name: Surname: Address:

☎ (Business): () ☎ (Home): ()

Enclosed is my money order cheque (Australia only) Please charge my credit card

American Express Bankcard MasterCard Visa Card #.....

Expiry date: Signature: Date: